

N, N4

Центробежные насосы с осевым всасыванием по стандартам EN 733



Конструкция

Центробежные насосы с одним рабочим колесом с осевым всасыванием на основании.

Номинальные тех. характеристики и основные размеры в соответствии со стандартом EN 733.

Конструкция со съемной задней частью для облегчения и ускорения установки и демонтажа.

Бронзовые насосы поставляются полностью окрашенными.

Номинальная частота вращения (50 Гц): **N** = 2900 об./мин.,
N4 = 1450 об./мин.

Раструбы: Фланцы PN 10, EN 1092-2.

Контрфланцы (по требованию)

Размеры	Фланцы
от 32-160 до 50-250	Резьбовые фланцы PN 16, EN 1092-1
от 65-125 до 150-400	Фланцы, свариваемые внахлестку по стандарту PN 10, EN 1092-1

Уплотнение на валу

механическое уплотнение стандартного типа согласно ISO 3069.
сальниковое уплотнение (по требованию)

Применение

Перекачка чистых жидкостей, не содержащих абразивных примесей и не агрессивных для материалов, из которых изготовлен насос (содержание твердых частиц максимум 0,2%).

Водоснабжение.

Использование в установках теплоснабжения, кондиционирования, охлаждения и циркуляции.

Использование в бытовой и промышленной сфере, в сельском хозяйстве.

Работа в противопожарных установках.

Ирригация.

Эксплуатационные ограничения

Температура жидкости от -10°C до +90°C.

Температура окружающего воздуха не более 40°C.

Манометрическая высота всасывания не более 7 м.

Максимально допустимое конечное давление в корпусе насоса: 10 бар (16 бар для N,N4 40-160,200; N,N4 50-125,160; N,N4 65-125,160,200,250; N,N4 80-160,315,400).

Максимально допустимая частота вращения – см. таблицу далее.

Электронасосы серии N, B-N, N4, B-N4, соответствуют европейскому регламенту N. 547/2012.

Конструкционные материалы

Составная часть	N, N4	B-N, B-N4	N, N4
Корпус насоса	Мех. уплотнение	Мех. уплотнение	Сальниковое уплотнение
Крышка корпуса	Чугун	Бронза	Чугун
Рабочее колесо	GJL 200 EN 1561	G-Cu Sn 10 EN 1982	GJL 200 EN 1561
	Чугун	Бронза	Чугун
	GJL 200 EN 1561	G-Cu Sn 10 EN 1982	GJL 200 EN 1561
	Латунь P- Cu Zn 40 Pb 2 UNI 5705 для мод. 32-125, 32-160, 32-200, 32L-200, 40-200		
Вал	Хромовая сталь 1.4104 EN 10088 AISI 430	сталь Cr-Ni-Mo AISI 316	Углеродистая сталь C 40 UNI 7845
Защитный кожух вала	—	—	Бронза G-Cu Sn5 Zn5 Pb5 EN 1982 с хромиров. поверхностью
Мех. уплотнение	Уголь - керамика - NBR		—
	Сталь-Уголь-NBR для N4 125,150-315 и N4 80,100,125,150-400		—
Контрфланцы	Сталь Fe 430B UNI 7070		

Двигатель–насосный агрегат

Насосы серии N, N4 соединены с электродвигателем стандартного типа конструкции типа В3 (IEC 72).

Класс энергосбережения IE3 для трехфазных двигателей мощностью от 0,75 кВт.

Защитное устройство типа IP 55, трехфазный, 400 В, 50 Гц, на опорной плите с эластичной соединительной частью, имеющей защитный кожух.

Двигатель предрасположен для работы с инвертором.

Специальные исполнения под заказ

- специальное мех. уплотнение
- вал насоса из хромоникелемолибденовой стали AISI 316
- для жидкости и окружающей среды с повышенной или пониженной температурой
- двигатель с другими типами защиты
- другие напряжения
- частота 60 Гц (см. каталог для частоты 60 Гц)



Область применения n = 2900 об./мин.

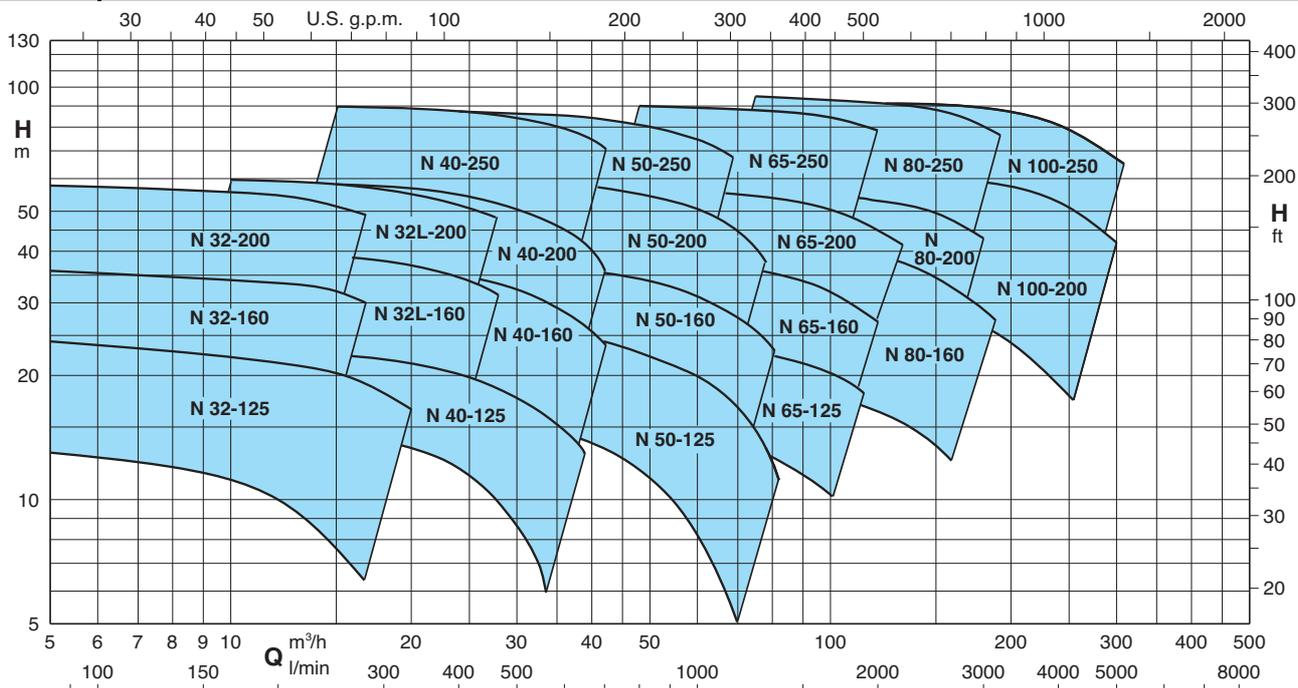

Допуски согласно стандарту UNI EN ISO 9906:2012.

Тех. характеристики n = 2900 в мин.

Насос	Насос	Двигатель	P ₂ kW	Q m³/h																		
				Q l/min	6,6	7,5	8,4	9,6	10,8	12	13,2	15	16,8	18,9	21	24	27	29	32	37,8	39	
B-N 32-125F/A	N 32-125F/A	71 M2	0,55	12,5	12,5	12	11,5	11	10,5	9,5	8	6										
B-N 32-125D/A	N 32-125D/A	80 M2	0,75	18	18	17,5	17	16,5	16	15,5	14	12,5	11	8,5								
B-N 32-125A/A	N 32-125A/A	80 M2	1,1	23	23	22,5	22	21,5	21	20,5	19,5	18	16	14	10							
B-N 32-125S/A	N 32-125S/A	90 S2	1,5	23,5	23,5	23	22,5	22	21,5	21	20,5	19	18,5	16,5	13							
B-N 32-160B/A	N 32-160B/A	90 S2	1,5	29,5	29,5	29	28,5	27,5	27	26	25*	22,5*	20*	17,5*	12,5*							
B-N 32-160A/A	N 32-160A/A	90 L2	2,2	35,5	35,5	35	34,5	34	33,5	33	32*	30*	28*	25*	21*	15*						
B-N 32-200D/A	N 32-200D/A	90 L2	2,2	37,5	37	36	35	34	33	32	30	27	22									
B-N 32-200C/A	N 32-200C/A	100 L2	3	44,5	44	43,5	43	42	41	40	38,5	36	32									
B-N 32-200A/A	N 32-200A/A	112 M2	4	57	56,5	56	55,5	54,5	53,5	52,5	51	49	46									
B-N 32-200A/A	N 32-200A/A	132 S2	5,5	2,9	3,1	3,18	3,35	3,51	3,67	3,8	4	4,2	4,4									
B-N 32L-160C	N 32L-160C	90 L2	2,2				25,1	24,9	24,7	24,4	23,8	23	21,8	17,3	13,4							
B-N 32L-160B	N 32L-160B	100 L2	3				30,4	30,3	30,2	30	29,6	29	28,1	26,8	24,2	20,8	17,9					
B-N 32L-160A	N 32L-160A	112 M2	4				39,9	39,9	39,8	39,6	39,3	38,8	37,9	36,8	34,7	31,9	29,7	25,6				
B-N 32L-200C	N 32L-200C	112 M2	4				42,1	41,8	41,5	41	40,2	38,9	37	34,5	29,7	23,8						
B-N 32L-200B	N 32L-200B	132 S2	5,5				51,7	51,6	51,4	51,2	50,7	50	48,8	47	43,2	37,8	33,5					
B-N 32L-200A	N 32L-200A	132 S2	7,5				59,4	59,4	59,4	59,4	59,2	58,8	58	56,5	53,4	48,6	44,6	37,7				

Насос	Насос	Двигатель	P ₂ kW	Q m³/h																		
				Q l/min	15	16,8	18,9	21	24	27	30	33	37,8	39	42	45	48	54	60	66	69	
B-N 40-125F/A	N 40-125F/A	80 M2	1,1	14	13,5	13	12	11	9,5	8	6											
B-N 40-125C/A	N 40-125C/A	90 S2	1,5	17,5	17	16,5	16	15	13,5	12	10,5	7,5	6,5									
B-N 40-125A/A	N 40-125A/A	90 L2	2,2	22	22	21,5	21	20	19	18	16,5	14	13	11,5								
B-N 40-160C/A	N 40-160C/A	90 L2	2,2	23	22,5	22	21,5	20	18,5	16,5	14,5	11	10									
B-N 40-160B/A	N 40-160B/A	100 L2	3	29	28,8	28	27,5	26,5	25	23,5	21,5	18	17	14								
B-N 40-160A/A	N 40-160A/A	112 M2	4	37	36,5	36,5	36	35	33,5	32	30,5	27	26	23,5	20	17						
B-N 40-200D/A	N 40-200D/A	112 M2	4	39	38	37	35,5	33,5	30,5	27	22,5	14										
B-N 40-200C/A	N 40-200C/A	132 S2	5,5	41,5	40,5	39,5	38	36	33,5													
B-N 40-200B/A	N 40-200B/A	132 S2	5,5	50	49,5	48,5	47,5	45,5	43,5	41,5	37,5	30,5										
B-N 40-200A/A	N 40-200A/A	132 S2	7,5	55	54,5	54	53	51	49													
B-N 40-200A/A	N 40-200A/A	132 S2	7,5	4,50	4,70	5,07	5,30	5,65	5,95													
B-N 40-250C/A	N 40-250C/A	160 M2	11	61	61	60,5	59,5	58,5	56,5	53,5	49,5	41,5	40	33,5								
B-N 40-250B/A	N 40-250B/A	160 M2	11	69,5	69,5	69	68,5	67	65,5	63,5	60,5	53,5	51	45								
B-N 40-250A/A	N 40-250A/A	160 M2	15	90	90	89,5	89	88,5	87	85	83	77,5	76	70,5								

P₂ Номинальная мощность двигателя P₃ Мощность, потребляемая насосом H Общая высота напора в м * Максимальная высота всасывания 1-2 м

Тех. характеристики n = 2900 об./мин.

Насос В-Н	Насос N	Двигатель	P ₂ kW	Q m³/h Q l/min	24	27	30	33	37,8	42	48	54	60	66	69	72	75	78	81	84	96		
					400	450	500	550	630	700	800	900	1000	1100	1150	1200	1250	1300	1350	1400	1600		
B-N 50-125F/A	N 50-125F/A	90 L2	2,2	H m P ₃ kW			15,5 1,87	15 1,93	14 2,02	13,5 2,09	12 2,14	10 2,18	8 2,10	6									
B-N 50-125D/A	N 50-125D/A	100 L2	3				20 2,5	19,5 2,58	18,5 2,7	18 2,81	16,5 2,96	14,5 2,98	13 2,98	10,5 2,92	9 2,9	8 2,87							
B-N 50-125A/A	N 50-125A/A	112 M2	4				24 3,11	24 3,22	23 3,39	22,5 3,54	21 3,69	19,5 3,78	17,5 3,85	15 3,87	14 3,87	12,5 3,84	11,5 3,81	10 3,79					
B-N 50-125S/A	N 50-125S/A	112 M2 132 S2	4 5,5				26,5 3,38	26 3,52	25,5 3,71	24,5 3,87	23,5 4,04	22 4,18	20 4,25	18 4,29	16,5 4,28	15,5 4,28	14 4,26	13 4,24	11 4,22				
B-N 50-160B/A	N 50-160B/A	132 S2	5,5				31 4,30	30,5 4,48	29,5 4,71	28 4,90	26 5,11	24 5,28	21,5 5,35	19 5,40	17,5 5,40	15,5 5,36	13,5 5,32	11,5 5,30	9,5 5,22				
B-N 50-160A/A	N 50-160A/A	132 S2	7,5				38,5 5,44	38 5,67	37,5 6,02	36,5 6,31	34,5 6,67	32,5 6,95	30 7,18	27 7,30	25,5 7,34	24 7,38	22,5 7,41	20,5 7,42	19 7,46				
B-N 50-200B/A	N 50-200B/A	160 M2	11			48 5,81	47,5 6,13	47,5 6,44	47 6,73	45,5 7,18	44,5 7,55	42,5 8,02	40 8,43	37 9,01	33 9,08	30,5 9,15	28 9,19	25,5 9,23	23 9,23				
B-N 50-200A/A	N 50-200A/A	160 M2	11			55 6,92	55 7,29	54,5 7,65	54,5 7,99	53,5 8,56	52 8,99	50 9,57	48 10,05	45 10,45	41,5 10,75	39,5 10,89	37 10,98	35 11,11	32,5 11,15				
B-N 50-200S/A	N 50-200S/A	160 M2	15			60 7,56	60 7,98	59,5 8,39	59,5 8,79	58,5 9,38	57,5 9,82	55,5 10,48	53,5 11,05	50,5 11,54	47 11,85	45 12,02	43 12,20	40,5 12,30	37 12,40				
B-N 50-250C/A	N 50-250C/A	160 M2	11			55 7,28	54,5 7,68	54 8,06	53 8,42	51,5 8,98	49,5 9,42	46,0 9,99	41,5 10,42	35,5 10,75	28,5 10,95	24,5 11,08							
B-N 50-250B/A	N 50-250B/A	160 M2	15			69 9,62	68,5 10,08	68 10,58	67,5 11,05	66 11,68	64 12,32	61 13,05	57 13,77	52,5 14,20	46,5 14,77	43 14,98							
B-N 50-250A/A	N 50-250A/A	160 L2	18,5			80,5 11,75	80,5 12,33	80 12,92	79,5 13,56	78,5 14,47	77 15,20	74,5 16,10	71,5 17,65	67 18,25	61,5 18,55	58,5							
B-N 50-250S/A	N 50-250S/A	180 M2	22			88,5 12,76	88,5 13,46	88 14,15	87 14,85	86 15,93	84 16,84	81,5 17,92	78,5 19,02	75 19,91	71 20,62	68,5 20,96							

Насос В-Н	Насос N	Двигатель	P ₂ kW	Q m³/h Q l/min	24	27	30	33	37,8	42	48	54	60	66	75	84	96	108	120	132	141		
					400	450	500	550	630	700	800	900	1000	1100	1250	1400	1600	1800	2000	2200	2350		
B-N 65-125E/B	N 65-125E/B	112 M2	4	H m P ₃ kW					16,5 2,86	16,4 2,99	16,2 3,17	15,9 3,34	15,5 3,5	15,1 3,64	14,3 3,81	13,2 3,94	11,4 4,03	9,2 4					
B-N 65-125C/B	N 65-125C/B	132 S2	5,5						21,1 3,68	21 3,86	20,8 4,11	20,6 4,35	20,3 4,57	19,9 4,77	19,1 5,02	18,2 5,23	16,5 5,41	14,4 5,5	11,8 5,49				
B-N 65-125A/B	N 65-125A/B	132 S2	7,5						25,9 4,71	25,8 4,92	25,6 5,21	25,4 5,5	25,1 5,77	24,8 6,03	24,1 6,38	23,3 6,69	21,9 7,02	20 7,25	17,6 7,36				
B-N 65-160D/B	N 65-160D/B	132 S2	7,5								24,3 5,11	24,1 5,44	23,9 5,75	23,6 6,05	23,1 6,45	22,3 6,8	20,8 7,15	18,8 7,4	16,3 7,52				
B-N 65-160C/B	N 65-160C/B	160 M2	11								28,1 5,89	28 6,26	27,8 6,61	27,6 6,96	27,1 7,44	26,3 7,87	24,9 8,37	23,1 8,74	20,7 8,98	17,7 9,06			
B-N 65-160B/B	N 65-160B/B	160 M2	11								32,6 7,04	32,5 7,44	32,3 7,84	32 8,22	31,5 8,76	30,8 9,25	29,5 9,84	27,9 10,33	25,7 10,7	23,0 10,96			
B-N 65-160AR	N 65-160AR	160 M2	15								36,4 7,98	36,3 8,45	36,2 8,91	35,9 9,36	35,5 9,99	34,8 10,57	33,7 11,27	32,1 11,85	30,0 12,33	27,5 12,71			
B-N 65-160A/B	N 65-160A/B	160 M2	15								40,5 8,91	40,4 9,44	40,2 9,96	40 10,47	39,5 11,19	38,8 11,85	37,6 12,64	36,1 13,33	34,2 13,92	31,7 14,42			
B-N 65-200C/B	N 65-200C/B	160 M2	15								44 9,2	43,8 9,8	43,5 10,4	43,1 10,9	42,3 11,7	41,2 12,3	39,4 13,1	37,1 13,8	34,4 14,3	31,4 14,8	28,8 15,1		
B-N 65-200B/B	N 65-200B/B	160 L2	18,5								50,5 10,9	50,4 11,5	50,2 12,2	49,9 12,8	49,2 13,7	48,3 14,6	46,8 15,6	44,8 16,4	42,5 17,2	39,8 17,9	37,5 18,3		
B-N 65-200A/B	N 65-200A/B	180 M2	22								57 13,3	57 14,1	57 14,9	56,5 15,6	56 16,7	55,5 17,7	54 18,4	52,5 19,1	50 20,1	47,5 21,1	45,5 22	43 22,5	
B-N 65-250C/B	N 65-250C/B	180 M2	22								61 13,5	61 14,5	60,5 15	60 16	58,5 17	57 18	54,5 19	51,5 20	47,5 21,5	43 22,5			
B-N 65-250B/B	N 65-250B/B	200 L2	30								73,5 18,5	73,5 19,5	73,5 20,5	73,5 21,5	73 22,5	71,5 24	69,5 25,5	66,5 27,5	63 29	59 30,5			
B-N 65-250A/B	N 65-250A/B	200 L2	37								86,5 22	86,5 23,5	87 24,5	86,5 26	86 27,5	85,5 29,5	83,5 31,5	81 34	78 35,5	74,5 37			

Насос В-Н	Насос N	Двигатель	P ₂ kW	Q m³/h Q l/min	60	66	75	84	96	108	120	132	150	168	180	192	210	240	270	300			
					1000	1100	1250	1400	1600	1800	2000	2200	2500	2800	3000	3200	3500	4000	4500	5000			
B-N 80-160E/B	N 80-160E/B	132 S2	7,5	H m P ₃ kW			21,5 6,81	20,9 6,92	19,9 7,05	18,7 7,15	17,4 7,22	15,9 7,26	13,4 7,27	10,6 7,21									
B-N 80-160D/B	N 80-160D/B	160 M2	11					25,2 8	24,5 8,22	23,5 8,49	22,4 8,73	21,1 8,93	19,6 9,09	17,2 9,23	14,4 9,23								
B-N 80-160C/B	N 80-160C/B	160 M2	11					28,7 9,04	28,2 9,35	27,4 9,74	26,4 10,09	25,1 10,39	23,8 10,65	21,3 10,91	18,5 10,99	16,4 10,93							
B-N 80-160B/B	N 80-160B/B	160 M2	15					34,8 11,37	34,5 11,83	33,8 12,42	33 13	32,1 13,53	30,9 14,01	28,9 14,63	26,4 15,07	24,5 15,26	22,4 15,34						
B-N 80-160A/B	N 80-160A/B	160 L2	18,5					39,9 13,25	39,6 13,82	39 14,58	38,2 15,3	37,4 15,99	36,4 16,62	34,5 17,45	32,2 18,09	30,3 18,4	28,1 18,59						
B-N 80-200B/A	N 80-200B/A	180 M2	22					46,5 15,7	46 16,6	45,5 17,7	44,5 18,6	43,5 19,4	42 20,2	39* 21,3	35,5* 21,8	32* 22							
B-N 80-200A/A	N 80-200A/A	200 L2	30					56 20	55,5 21,1	55 22,3	54 23,5	53 24,7	52 25,7	49,5* 27,2	46* 28,5	43* 29,3							
B-N 80-250E/A	N 80-250E/A	180 M2	22					51 16,2	50 17,1	48,5 18,2	46,5 19,1	44,5 20	42 20,6	38* 21,4	33* 21,9	29* 22							
B-N 80-250D/A	N 80-250D/A	200 L2	30					65 21,9	64 22,3	62,5 24	61 25,3	59 26,5	56,5 27,5	53* 28,6	49* 29,4	45,5* 29,9	41* 30						
B-N 80-250C/A	N 80-250C/A	200 L2	37					73,5 24,9	73 26	72 27,8	70,5 29,5	69 31	67 32,4	63* 33,8	59* 35,2	55,5* 36,2	51,5* 36,2						
B-N 80-250B/A	N 80-250B/A	225 M2	45					84 29	83,5 30,7	82,5 32,9	81,5 35	80 36,7	78 38,3	74,5* 40,1	70,5* 41,8	67* 43	63* 44,1						
B-N 80-250A/A	N 80-250A/A	250 M2	55					95 33,7	94,5 35,6	93,5 38,1	92,5 40,5	91,5 42,7	90 44,8	87,5* 47,4	84* 49,7	80,5* 51,5	76,5* 53						
B-N 100-200E/A	N 100-200E/A	160 L2	18,5								30 14,5	29,5 15,1	29 15,7	28 16,3	27 17,2	26 17,9	25 18,3	23 18,4	19* 18,4				
B-N 100-200D/A	N 100-200D/A	180 M2	22								36 17,1	35,5 17,8	35 18,5	34 19,5	33 20,2	32 21,1	29 21,6	24,5* 21,6	19* 22				
B-N 100-200C/A	N 100-200C/A	200 L2	30								45 22	44,5 22,9	44 23,9	43,5 25,1	42,5 26,2	41,5 26,9	40,5						

Область применения n = 1450 об./мин.

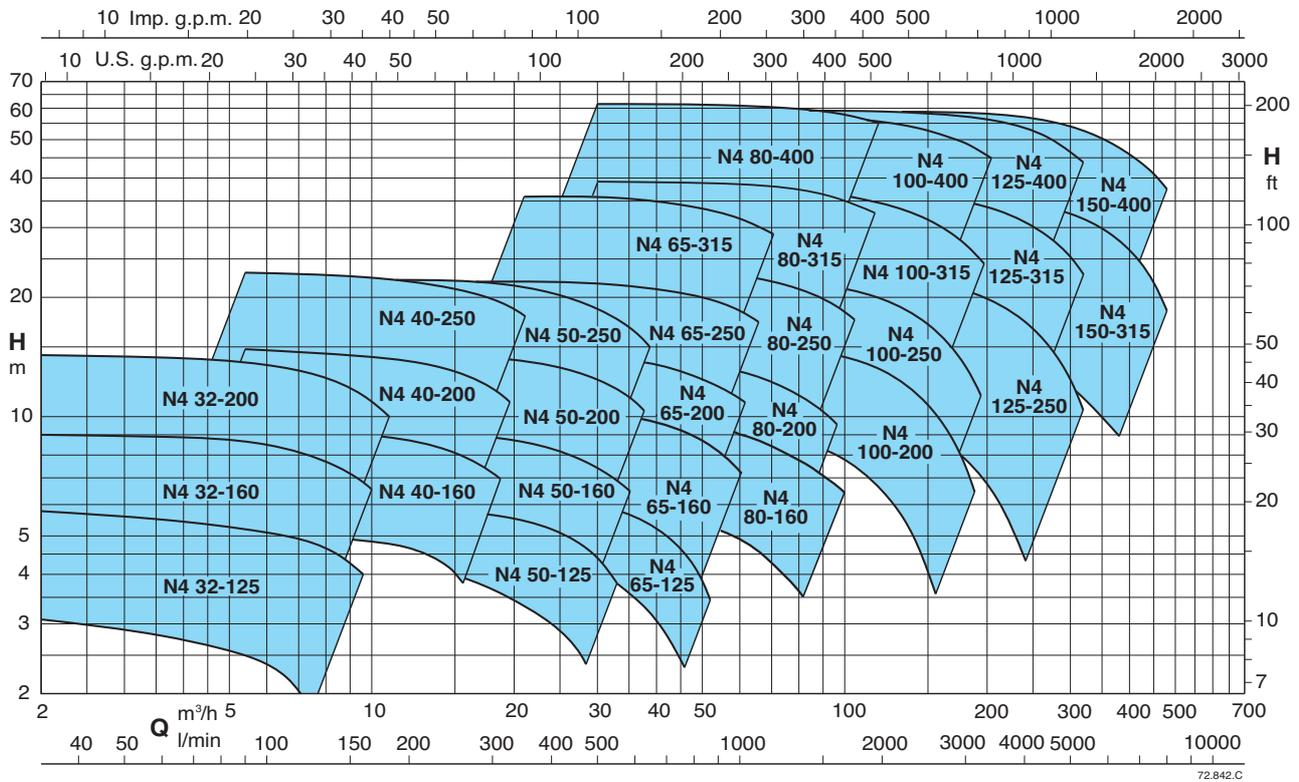

Допуски согласно стандарту UNI EN ISO 9906:2012.

Тех. характеристики n = 1450 об./мин.

Насос	Насос	Двигатель	P ₂ kW	Q															
				m³/h	2,4	3	3,6	4,2	4,8	5,4	6	6,6	7,5	8,4	9,6	10,8	12	13,2	
B-N4 32-125F/A	N4 32-125F/A	71 M4	0,25	3,6	3,6	3,5	3,5	3,4	3,2	3	2,8	2,4	1,9	1,1					
B-N4 32-125D/A	N4 32-125D/A	71 M4	0,25	4,7	4,7	4,7	4,7	4,6	4,6	4,5	4,3	4,1	3,8	3,3	2,6				
B-N4 32-125A/A	N4 32-125A/A	71 M4	0,25	5,7	5,8	5,8	5,7	5,7	5,7	5,6	5,5	5,4	5,2	4,8	4,3				
B-N4 32-160B/A	N4 32-160B/A	71 M4	0,37	7,6	7,5	7,4	7,3	7,2	7,1	6,9	6,7	6,3	5,9	5,2	4,2				
B-N4 32-160A/A	N4 32-160A/A	71 M4	0,37	9	8,95	8,9	8,8	8,7	8,6	8,5	8,3	7,9	7,5	6,8	6	5,1			
B-N4 32-200B/A	N4 32-200B/A	80 M4	0,55	12,5	12,4	12,3	12,2	12	11,8	11,6	11,2	10,6	10	8,9	7,6	6,2	4,7		
B-N4 32-200A/A	N4 32-200A/A	80 M4	0,75	14,3	14,2	14,1	14	13,9	13,7	13,5	13,3	12,9	12,3	11,3	10,2	8,9	7,5		

Насос	Насос	Двигатель	P ₂ kW	Q															
				m³/h	5,4	6	6,6	7,5	8,4	9,6	10,8	12	13,2	15	16,8	18,9	21	24	27
B-N4 40-160C/A	N4 40-160C/A	71 M4	0,37	6,1	6	5,9	5,9	5,8	5,6	5,4	5,2	5	4,5	3,9	3,1	2,3			
B-N4 40-160B/A	N4 40-160B/A	80 M4	0,55	7,6	7,6	7,6	7,6	7,6	7,3	7,1	6,9	6,6	6,3	5,7	5	4	2,7		
B-N4 40-160A/A	N4 40-160A/A	80 M4	0,75	9,6	9,6	9,6	9,6	9,4	9,3	9,1	9	8,8	8,4	7,9	7,2	6,4	5,1	3,5	
B-N4 40-200B/A	N4 40-200B/A	90 S4	1,1	13	12,9	12,8	12,7	12,6	12,4	12,2	12	11,5	10,8	10	8,6	7			
B-N4 40-200A/A	N4 40-200A/A	90 S4	1,1	14,8	14,7	14,6	14,5	14,4	14,2	14	13,8	13,6	13	12,2	11,3	10			
B-N4 40-250C/A	N4 40-250C/A	90 L4	1,5	17,4	17,3	17,2	17,2	17	16,8	16,6	16,3	16	15,1	13,8	12,1	10,4	7,2	2,8	
B-N4 40-250B/A	N4 40-250B/A	100 LA4	2,2	21,4	21,5	21,4	21,3	21,2	21	20,9	20,8	20,5	20	19,5	18,3	16,4	13,3	10	5
B-N4 40-250A/A	N4 40-250A/A	100 LB4	3	22,9	22,8	22,9	22,9	22,8	22,5	22,5	22,2	22	21,8	21,4	20,4	18,9	16	12,6	8

N4 Стандартное исполнение P₂ Номинальная мощность двигателя H Общая высота напора в м * Максимальная высота всасывания 1-2 м
 B-N4 Исполнение из бронзы P₃ Мощность, потребляемая насосом

Тех. характеристики n = 1450 об./мин.

Насос В-N4	Насос N4	Двигатель	P ₂ kW	Q m ³ /h	10,8	12	13,2	15	16,8	18,9	21	24	27	30	33	37,8	42	48			
				Q l/min	180	200	220	250	280	315	350	400	450	500	550	630	700	800			
B-N4 50-125F/A	N4 50-125F/A	71 M4	0,37	H m P ₃ kW	4,5 0,26	4,5 0,275	4,4 0,285	4,3 0,3	4,1 0,31	3,8 0,32	3,5 0,325	2,9 0,33	2,2 0,325	1,4 0,315	0,5 0,3						
B-N4 50-125D/A	N4 50-125D/A	80 M4	0,55		5,5 0,32	5,5 0,335	5,4 0,345	5,4 0,365	5,2 0,385	5,1 0,4	4,8 0,415	4,4 0,425	3,8 0,435	3,2 0,43	2,5 0,425						
B-N4 50-125A/A	N4 50-125A/A	80 M4	0,75		6,4 0,37	6,4 0,39	6,3 0,405	6,3 0,425	6,2 0,45	6,1 0,47	5,9 0,49	5,6 0,51	5,2 0,525	4,6 0,535	4 0,535	2,9 0,525					
B-N4 50-125S/A	N4 50-125S/A	80 M4	0,75		6,8 0,4	6,8 0,42	6,8 0,435	6,8 0,46	6,7 0,48	6,6 0,505	6,4 0,525	6,2 0,555	5,8 0,57	5,3 0,585	4,8 0,59	3,8 0,59					
B-N4 50-160B/A	N4 50-160B/A	90 S4	1,1		8,2 0,449	8,2 0,469	8,2 0,496	8,1 0,524	8 0,555	7,8 0,584	7,6 0,610	7,2 0,643	6,7 0,671	6,2 0,683	5,5 0,692	4,4 0,687	3,3 0,673				
B-N4 50-160A/A	N4 50-160A/A	90 S4	1,1		9,6 0,555	9,6 0,578	9,6 0,600	9,5 0,632	9,5 0,670	9,3 0,705	9,1 0,742	8,8 0,778	8,3 0,811	7,8 0,833	7,2 0,850	6,1 0,862	4,9 0,861	3,1 0,844			
B-N4 50-200C/A	N4 50-200C/A	90 S4	1,1		11,8 0,617	11,8 0,647	11,7 0,682	11,7 0,720	11,5 0,759	11,3 0,801	10,9 0,841	10,4 0,888	9,8 0,927	9 0,957	8,1 0,979	6,3 1,005	4,7 1,010				
B-N4 50-200B/A	N4 50-200B/A	90 L4	1,5		13,4 0,772	13,4 0,807	13,4 0,840	13,3 0,889	13,1 0,949	12,9 0,998	12,6 1,051	12,1 1,115	11,5 1,171	10,8 1,213	9,9 1,251	8,2 1,278	6,4 1,299	3,7 1,301			
B-N4 50-200A/A	N4 50-200A/A	100 L4	2,2		14,9 0,883	14,9 0,923	14,9 0,962	14,9 1,019	14,8 1,074	14,6 1,135	14,4 1,194	14 1,273	13,4 1,345	12,8 1,409	12 1,464	10,4 1,535	8,6 1,576	6 1,596			
B-N4 50-250D/A	N4 50-250D/A	100 L4	2,2		14,5 0,843	14,4 0,886	14,3 0,929	14 0,990	13,7 1,049	13,4 1,098	13 1,160	12,2 1,230	11,2 1,300	9,7 1,364	8,1 1,395	5,4 1,435	2,3 1,468				
B-N4 50-250C/A	N4 50-250C/A	100 L4	2,2		17,8 1,091	17,8 1,140	17,7 1,188	17,5 1,258	17,2 1,324	16,8 1,397	16,4 1,465	15,7 1,554	14,9 1,633	13,8 1,700	12,4 1,755	9,7 1,817	6,8 1,844				
B-N4 50-250B/A	N4 50-250B/A	100 L4	3		20,7 1,374	20,7 1,437	20,7 1,499	20,6 1,591	20,4 1,680	20 1,781	19,5 1,878	18,9 2,009	18,2 2,130	17,1 2,241	15,9 2,320	13,2 2,448	10,6 2,510	5,8 2,580			
B-N4 50-250A/A	N4 50-250A/A	112 M4	4		22,7 1,493	22,7 1,561	22,6 1,628	22,5 1,728	22,4 1,825	22,1 1,935	21,6 2,042	21 2,186	20,2 2,322	19,4 2,445	18,3 2,557	16,4 2,704	13,6 2,804	9 2,893			

Насос В-N4	Насос N4	Двигатель	P ₂ kW	Q m ³ /h	21	24	27	30	33	37,8	42	48	54	60	66	75	84	96	108	120	
				Q l/min	350	400	450	500	550	630	700	800	900	1000	1100	1250	1400	1600	1800	2000	
B-N4 65-125E/B	N4 65-125E/B	80 M4	0,75	H m P ₃ kW	4,1 0,38	4,1 0,4	4 0,41	3,9 0,44	3,8 0,45	3,6 0,48	3,3 0,49	2,9 0,5	2,3 0,5								
B-N4 65-125C/B	N4 65-125C/B	80 M4	0,75		5,3 0,49	5,2 0,51	5,2 0,54	5,1 0,58	5 0,6	4,8 0,63	4,6 0,65	4,1 0,69	3,6 0,69	3 0,69							
B-N4 65-125A/B	N4 65-125A/B	90 S4	1,1		6,5 0,61	6,4 0,65	6,4 0,69	6,3 0,73	6,2 0,75	6 0,8	5,8 0,84	5,5 0,91	5 0,93	4,4 0,93							
B-N4 65-160C/B	N4 65-160C/B	90 S4	1,1		6,1 0,57	6,1 0,61	6 0,65	6 0,69	5,9 0,72	5,8 0,78	5,6 0,83	5,3 0,88	4,8 0,92	4,2 0,93							
B-N4 65-160B/B	N4 65-160B/B	90 S4	1,1		7,2 0,68	7,1 0,73	7,1 0,77	7 0,82	7 0,86	6,8 0,92	6,6 0,97	6,3 1,03	5,8 1,07	5,2 1,11	4,5 1,12						
B-N4 65-160A/B	N4 65-160A/B	90 L4	1,5		8,8 0,87	8,8 0,93	8,7 0,98	8,7 1,04	8,6 1,09	8,5 1,17	8,3 1,24	8 1,32	7,6 1,39	7,1 1,44	6,4 1,48	5,2 1,51					
B-N4 65-160S	N4 65-160S	100 L4	2,2		10,2 1,09	10,2 1,15	10,1 1,22	10,1 1,28	10 1,34	9,9 1,44	9,7 1,52	9,4 1,62	9,1 1,71	8,6 1,79	8 1,86	7 1,93	5,7 1,96				
B-N4 65-200B/B	N4 65-200B/B	100 L4	2,2		11,7 1,25	11,7 1,3	11,6 1,35	11,6 1,45	11,5 1,5	11,3 1,6	11 1,7	10,6 1,8	10,1 1,9	9,5 2	8,7 2,05	7,4 2,15	5,8 2,2	3,3 2,15			
B-N4 65-200A/B	N4 65-200A/B	100 L4	3		14,2 1,55	14,2 1,65	14,2 1,75	14,1 1,85	14,1 1,95	13,9 2,1	13,7 2,2	13,4 2,35	13 2,5	12,5 2,65	11,8 2,75	10,7 2,9	9,3 3	7 3,05			
B-N4 65-250B/B	N4 65-250B/B	112 M4	4		17,9 1,95	18 2,05	18 2,2	18 2,3	18 2,45	17,8 2,6	17,5 2,75	17 2,95	16,3 3,15	15,4 3,3	14,4 3,45	12,5 3,65	10,4 3,75	7 3,85			
B-N4 65-250A/B	N4 65-250A/B	132 S4	5,5		22,2 2,55	22,3 2,7	22,4 2,85	22,4 3	22,4 3,15	22,2 3,4	22 3,6	21,6 3,85	21 4,1	20,2 4,35	19,3 4,6	17,6 4,85	15,7 5,1	12,6 5,3			
B-N4 65-315C/A	N4 65-315C/A	132 S4	5,5		25,8 3,12	25,7 3,31	25,5 3,49	25,3 3,67	25 3,83	24,4 4,05	23,8 4,25	22,8 4,5	21,5 4,75	20 4,95	18,2 5,12	15 5,3	11 5,4				
B-N4 65-315B/A	N4 65-315B/A	132 M4	7,5		31 3,97	31 4,23	30,9 4,45	30,8 4,65	30,6 4,85	30,2 5,15	29,7 5,4	28,8 5,75	27,8 6,1	26,5 6,4	25 6,65	22,2 7	18,6 7,2				
B-N4 65-315A/A	N4 65-315A/A	160 M4	11		35,9 4,8	35,9 5,1	35,8 5,4	35,7 5,6	35,5 5,8	35,1 6,15	34,6 6,5	33,8 6,9	32,8 7,3	31,6 7,6	30,2 7,9	27,8 8,3	25 8,7				

Насос В-N4	Насос N4	Двигатель	P ₂ kW	Q m ³ /h	30	33	37,8	42	48	54	60	66	75	84	96	108	120	132	150	168	180	
				Q l/min	500	550	630	700	800	900	1000	1100	1250	1400	1600	1800	2000	2200	2500	2800	3000	
B-N4 80-160C/B	N4 80-160C/B	90 S4	1,1	H m P ₃ kW	6,1 0,87	6,1 0,88	5,9 0,9	5,8 0,92	5,5 0,95	5,2 0,98	4,9 1	4,6 1,02	4 1,03	3,3 1,04								
B-N4 80-160B/B	N4 80-160B/B	90 L4	1,5		7,8 1,14	7,7 1,16	7,6 1,2	7,5 1,23	7,3 1,27	7 1,31	6,8 1,34	6,4 1,37	5,9 1,41	5,2 1,44	4,1 1,46							
B-N4 80-160A/B	N4 80-160A/B	100 L4	2,2		10 1,49	10 1,53	9,9 1,6	9,8 1,66	9,7 1,74	9,5 1,82	9,3 1,9	9 1,97	8,5 2,07	8 2,15	7 2,22	5,9 2,24						
B-N4 80-200C/A	N4 80-200C/A	100 L4	2,2		10,3 1,56	10,2 1,62	10,1 1,7	10 1,77	9,8 1,86	9,5 1,93	9,1 2	8,6 2,06	7,7 2,13	6,6 2,18	4,6 2,2							
B-N4 80-200B/A	N4 80-200B/A	100 L4	3		12,1 1,8	12 1,88	11,9 2	11,8 2,11	11,7 2,22	11,4 2,33	11,1 2,43	10,6 2,52	9,8 2,62	9 2,68	7,5 2,72	5,7 2,72						
B-N4 80-200A/A	N4 80-200A/A	112 M4	4		13,9 2,13	13,8 2,22	13,7 2,35	13,6 2,48	13,5 2,65	13,3 2,8	13 2,94	12,6 3,05	11,8 3,2	11 3,35	9,6 3,44	7,9 3,46	6 3,44					
B-N4 80-250C/A	N4 80-250C/A	112 M4	4		16,9 2,37	16,8 2,5	16,7 2,65	16,6 2,8	16,3 3	15,9 3,2	15,4 3,35	14,8 3,49	13,9 3,68	12,7 3,83	11,1 3,97	9,3 3,98	7,2 3,88					
B-N4 80-250B/A	N4 80-250B/A	132 S4	5,5		20,7 3,25	20,6 3,38	20,5 3,58	20,4 3,75	20,3 4	20 4,23	19,6 4,42	19,1 4,6	18,2 4,87	17,1 5,13	15,4 5,35	13,5 5,49	11,4 5,55	9,5 5,45				
B-N4 80-250A/A	N4 80-250A/A	132 M4	7,5		23,7 3,94	23,7 4,1	23,6 4,33	23,5 4,54	23,3 4,83	23 5,08	22,7 5,33	22,2 5,58	21,5 5,91	20,5 6,23	19 6,52	17,2 6,82	15,1 6,98	12,7 7,05				
B-N4 80-315C/B	N4 80-315C/B	160 M4	11		25,7 4,6	25,8 4,8	25,8 5,1	25,8 5,4	25,8 5,7	25,6 6,1	25,4 6,4	25 6,7	24,4 7,2	23,6 7,6	22,2 8,1	20,4 8,5	18,3 8,9	15,9 9,2				
B-N4 80-315B/B	N4 80-315B/B	160 M4	11		30,3 5,3	30,5 5,5	30,6 5,9	30,7 6,2	30,7 6,6	30,7 7	30,5 7,5	30,2 7,9	29,6 8,5	28,8 9	27,5 9,7	25,9 10,2	22 10,8					
B-N4 80-315A/B	N4 80-315A/B	160 L4	15		36,3 6,7	36,4 6,9	36,5 7,3	36,6 7,7	36,6 8,2	36,5 8,7	36,4 9,2	36,1 9,7	35,6 10,4	35 11,1	32,5 11,7	32,5 12,7	30,9 13,4	29 14	25,3 14,8			
B-N4 80-315S	N4 80-315S	180 M4	18																			

Тех. характеристики n = 1450 об./мин.

Насос В-N4	Насос N4	Двигатель	P ₂ kW	Q m ³ /h																			
				Q l/min	48	54	60	66	75	84	96	108	120	132	150	168	180	192	210				
B-N4 100-200C/A	N4 100-200C/A	100 L4	3	H _m	800	900	1000	1100	1250	1400	1600	1800	2000	2200	2500	2800	3000	3200	3500				
					9,4 2,65	9,3 2,2	9,2 2,3	9,1 2,4	8,9 2,5	8,5 2,6	8 2,7	7,3 2,8	6,5 2,85	5,6 2,9	4 2,85								
					12 3,65	11,9 3,85	11,8 4	11,7 4,15	11,5 4,4	11,2 4,6	10,7 4,85	10 5,1	9,3 5,3	8,4 5,45	6,7 5,55	4,5 5,65							
					15,2 4,8	15,2 5	15,1 5,2	15 5,4	14,9 5,75	14,7 6,05	14,3 6,4	13,8 6,7	13,1 7,3	12,2 7,5	10,7 7,5	9 7,5	7,5 7,5	6* 5,55					
					19,5 5,5	19,5 5,8	19,4 6,05	19,3 6,25	19 6,6	18,7 6,95	18,2 7,35	17,5 7,75	16,6 8,1	15,6 8,35	13,8 8,7	11,7 9	10 9,05	8,4 9,05	5,5 8,9				
					22,3 6,6	22,3 7	22,2 7,35	22,1 7,65	21,9 8,1	21,7 8,5	21,2 9	20,5 9,5	19,8 9,85	18,8 10,2	17,1 10,7	15 10,9	13,4 11	11,7 11	8,9 11				
					26,9 7,8	26,9 8,25	26,8 8,65	26,6 9	26,2 9,6	25,7 10,2	24,9 10,9	23,8 11,5	23,8 12,1	22,7 12,6	21,3 13,3	18,9 13,9	16,9 14,1	15,9 14,4	13,7 14,4	11,3* 14,4			
					31,5 9,7	31,5 10,2	31,4 10,7	31,3 11,2	31,2 11,9	30,8 12,5	30,2 13,3	29,3 14,1	28,2 14,9	26,9 15,6	24,6 16,6	21,8 17,4	19,8 17,9	17,6* 18,3	14,4* 18,75				
					36,9 11,1	36,9 11,8	36,8 12,5	36,7 13,2	36,6 14,1	36 14,7	35,3 15,4	34,5 16,2	33,4 16,7	31,4 17,3	29,2 17,9	27,2 18,5	25,3* 19,1	22,2* 19,7					
					41,3 11,8	41,2 11,8	41,1 12,5	41 13,2	40,7 14	40,4 14,8	39,8 16	39 17	38 18	36,5 18,9	34 20	31 21	28,7 21,7	26 22					
B-N4 100-400C/A	N4 100-400C/A	180 L4	22	H _m	84	96	108	120	132	150	168	180	192	210	240	270	300	330					
					11 4,2	10,8 4,5	10,5 4,75	10,1 4,95	9,7 5,05	9,1 5,2	8,3 5,35	7,8 5,45	7,2 5,5	6,2 5,5	4,4 5,35								
					14 5,4	13,9 5,7	13,7 5,95	13,4 6,2	13 6,45	12,4 6,75	11,6 7	11 7,1	10,4 7,2	9,4 7,35	7,4 7,4	5,1 7,1							
					16,7 6,3	16,6 6,7	16,4 7,1	16,2 7,4	15,9 7,65	15,4 8,05	14,6 8,4	14,1 8,6	13,5 8,75	12,5 9	10,4 9,2	8,2 9,05	5,8 9,05						
					19,3 7,8	19,2 8,25	19,1 8,7	18,9 9,1	18,7 9,45	18,2 10	17,5 10,35	17 10,6	16,3 10,85	15,3 11,1	13,3 11,4	10,9 11,45	8,2 11,3						
					22,7 9,2	22,7 9,75	22,6 10,3	22,4 10,85	22,2 11,3	21,8 12	21,2 12,6	20,8 12,95	20,1 13,25	19,33 13,75	17,4 14,3	15 14,5	12,4 14,55	9,3 14,4					
					27,9 11,5	27,8 12,15	27,7 12,8	27,6 13,4	27,2 14	26,5 14,7	25,6 15,4	24,9 15,8	24,2 16,2	22,8 16,7	20,2 17,3	17 17,7	13,5 18	9,5* 18					
					31,8 12,75	31,7 13,6	31,6 14,45	31,5 15,3	31,1 15,9	30,6 16,8	29,7 17,7	29,1 18,4	28,5 19	27,3 19,7	24,9 20,6	22 21,4	18,5 22	14,3* 22,1					
					36,8 15,5	36,8 16,5	36,7 17,5	36,6 18,3	36,4 19,1	35,9 20,4	35,2 21,6	34,7 22,4	34,2 23,1	33,2 24,15	31 25,6	28,4 26,6	25,3 27,6	21,6* 28,45					
					45,4 19,4	45,3 20,7	45,2 22	45,1 23,3	44,9 24,6	44,4 26,5	43,7 28,2	43 29,3	42 30,2	40 31,4	37 33,4	33 35	28,5* 35,9	23,5* 36,75					
51,4 22,9	51,3 24,3	51,2 25,7	51,1 27,1	50,9 28,4	50,4 30,35	49,7 32,2	49 33,3	48,2 34,4	46,8 36	44 38,5	40,5 41	36* 43	31,5* 44,5										
59,2 27,8	59,1 29,4	59 30,9	58,9 32,4	58,7 33,9	58,2 36,2	57,7 38,4	57,2 39,8	56,7 41,2	55,7 43,2	53,5 46,2	50,5 49,2	46,5* 52,1	42,5* 54,4										

Насос В-N4	Насос N4	Двигатель	P ₂ kW	Q m ³ /h																			
				Q l/min	84	96	108	120	132	150	168	180	192	210	240	270	300	330					
B-N4 125-250E/A	N4 125-250E/A	132 S4	5,5	H _m	1400	1600	1800	2000	2200	2500	2800	3000	3200	3500	4000	4500	5000	5500					
					11 4,2	10,8 4,5	10,5 4,75	10,1 4,95	9,7 5,05	9,1 5,2	8,3 5,35	7,8 5,45	7,2 5,5	6,2 5,5	4,4 5,35								
					14 5,4	13,9 5,7	13,7 5,95	13,4 6,2	13 6,45	12,4 6,75	11,6 7	11 7,1	10,4 7,2	9,4 7,35	7,4 7,4	5,1 7,1							
					16,7 6,3	16,6 6,7	16,4 7,1	16,2 7,4	15,9 7,65	15,4 8,05	14,6 8,4	14,1 8,6	13,5 8,75	12,5 9	10,4 9,2	8,2 9,05	5,8 9,05						
					19,3 7,8	19,2 8,25	19,1 8,7	18,9 9,1	18,7 9,45	18,2 10	17,5 10,35	17 10,6	16,3 10,85	15,3 11,1	13,3 11,4	10,9 11,45	8,2 11,3						
					22,7 9,2	22,7 9,75	22,6 10,3	22,4 10,85	22,2 11,3	21,8 12	21,2 12,6	20,8 12,95	20,1 13,25	19,33 13,75	17,4 14,3	15 14,5	12,4 14,55	9,3 14,4					
					27,9 11,5	27,8 12,15	27,7 12,8	27,6 13,4	27,2 14	26,5 14,7	25,6 15,4	24,9 15,8	24,2 16,2	22,8 16,7	20,2 17,3	17 17,7	13,5 18	9,5* 18					
					31,8 12,75	31,7 13,6	31,6 14,45	31,5 15,3	31,1 15,9	30,6 16,8	29,7 17,7	29,1 18,4	28,5 19	27,3 19,7	24,9 20,6	22 21,4	18,5 22	14,3* 22,1					
					36,8 15,5	36,8 16,5	36,7 17,5	36,6 18,3	36,4 19,1	35,9 20,4	35,2 21,6	34,7 22,4	34,2 23,1	33,2 24,15	31 25,6	28,4 26,6	25,3 27,6	21,6* 28,45					
					45,4 19,4	45,3 20,7	45,2 22	45,1 23,3	44,9 24,6	44,4 26,5	43,7 28,2	43 29,3	42 30,2	40 31,4	37 33,4	33 35	28,5* 35,9	23,5* 36,75					

Насос В-N4	Насос N4	Двигатель	P ₂ kW	Q m ³ /h																			
				Q l/min	132	150	168	180	192	210	240	270	300	330	360	390	420	450	480				
B-N4 150-315D/A	N4 150-315D/A	180 M4	18,5	H _m	2200	2500	2800	3000	3200	3500	4000	4500	5000	5500	6000	6500	7000	7500	8000				
					22,8 13,8	22,6 14,5	22,3 15	22 15,4	21,7 15,75	21,1 16,2	20 16,9	18,6 17,6	17 18	15,1 18,35	13 18,45	10,6 18,4	8* 18,15						
					25,6 15,6	25,4 16,44	25,1 17,2	24,9 17,65	24,7 18,1	24,2 18,8	23,3 19,7	22 20,6	20,4 21,3	18,5 21,75	16,5 22	14,1 22	11,6* 22	8,9* 21,65					
					30,6 19	30,6 20	30,5 21	30,3 21,6	30,1 22,15	29,7 23	29,7 24,35	29,7 25,7	29,9 26,6	26,5 27,5	23 28,1	18,3* 28,9	15,4* 29						
					35,6 23,1	35,6 24,4	35,5 25,7	35,4 26,5	35,3 27,2	35,2 28,3	34,6 30	33,7 31,6	33,7 33,1	32,5 34,3	31 35,4	29,2 36,3	27,1 37	24,7* 37,5	21,8* 37,5	18,5* 37,8			
					45 31,4	44,9 33,6	44,7 35,8	44,5 36,9	44 38,2	43,5 40	42,5 42,8	40,5 45,5	40,5 47,7	38,5 49,8	36 51,5	33,5 53	30,5 54,1	27* 54,1	23,5* 54,6	19,5* 54,8			
					50,8 38,2	50,7 40,7	50,5 42,8	50,3 44,35	50 45,7	49,5 48	48,5 51,5	47 54,4	47 57,1	45 59,7	43 62	40,5 64,2	38 66	35* 67,5	32* 68,4	28,5* 68,4			

N4 Стандартное исполнение P₂ Номинальная мощность двигателя H Общая высота напора в м * Максимальная высота всасывания 1-2 м
 B-N4 Исполнение из бронзы P₃ Мощность, потребляемая насосом



Характеристические кривые $n \approx 2900$ об./мин.

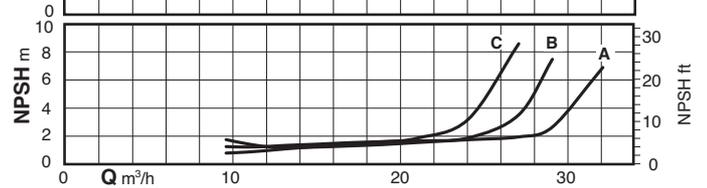
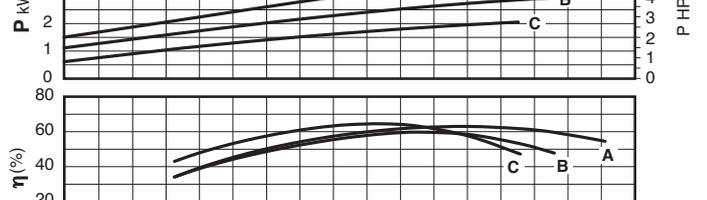
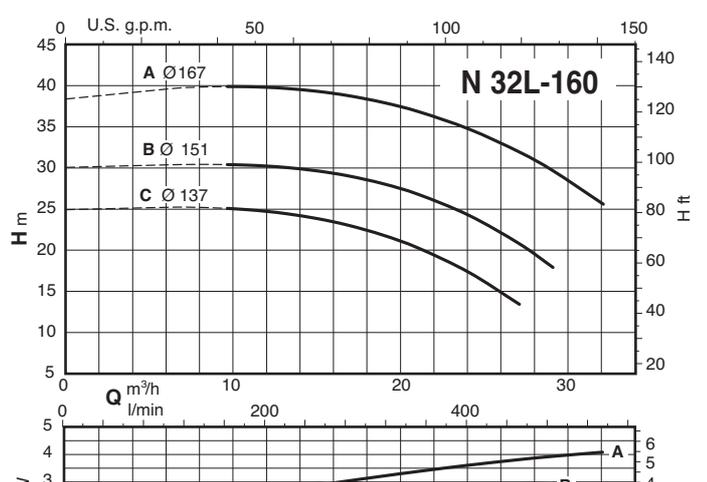
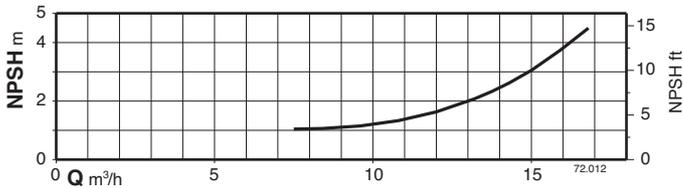
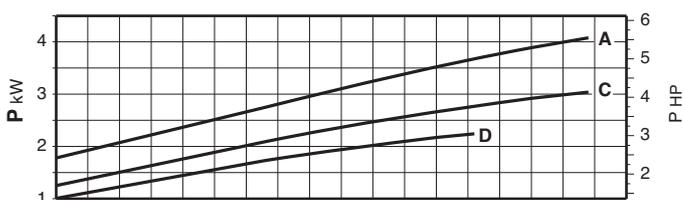
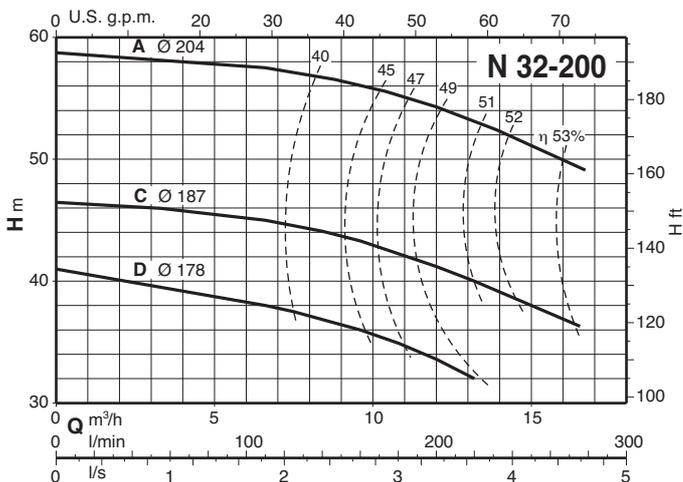
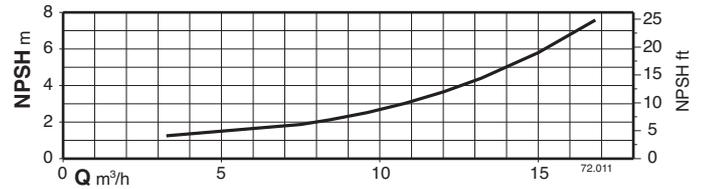
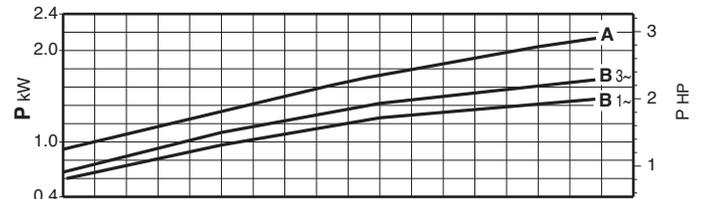
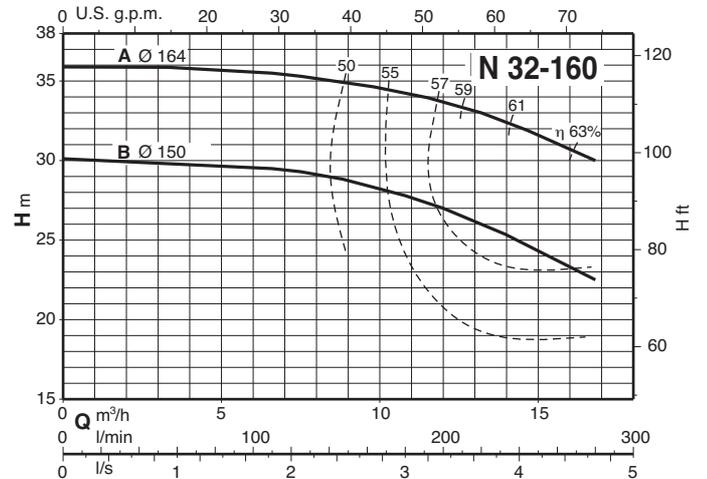
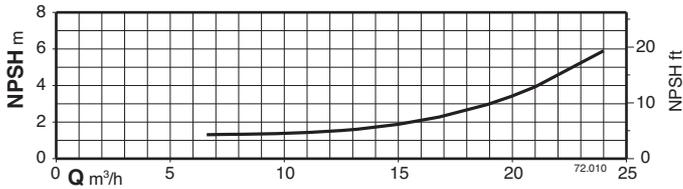
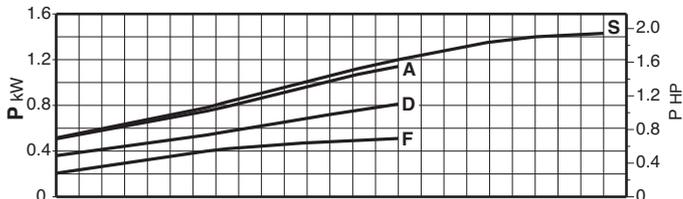
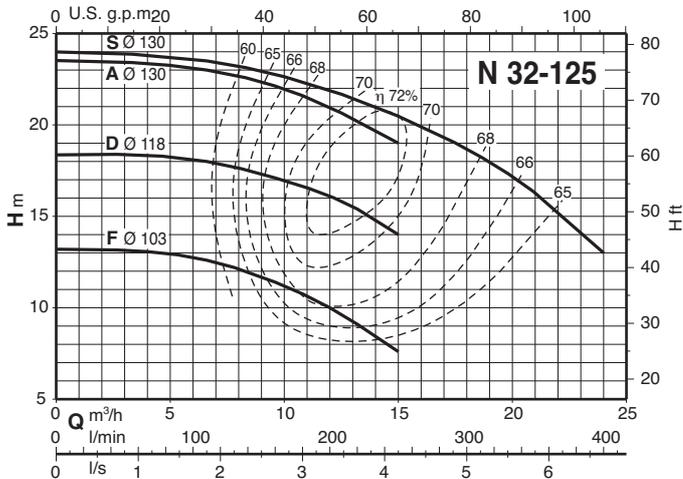

Характеристические кривые $n \approx 2900$ об./мин.

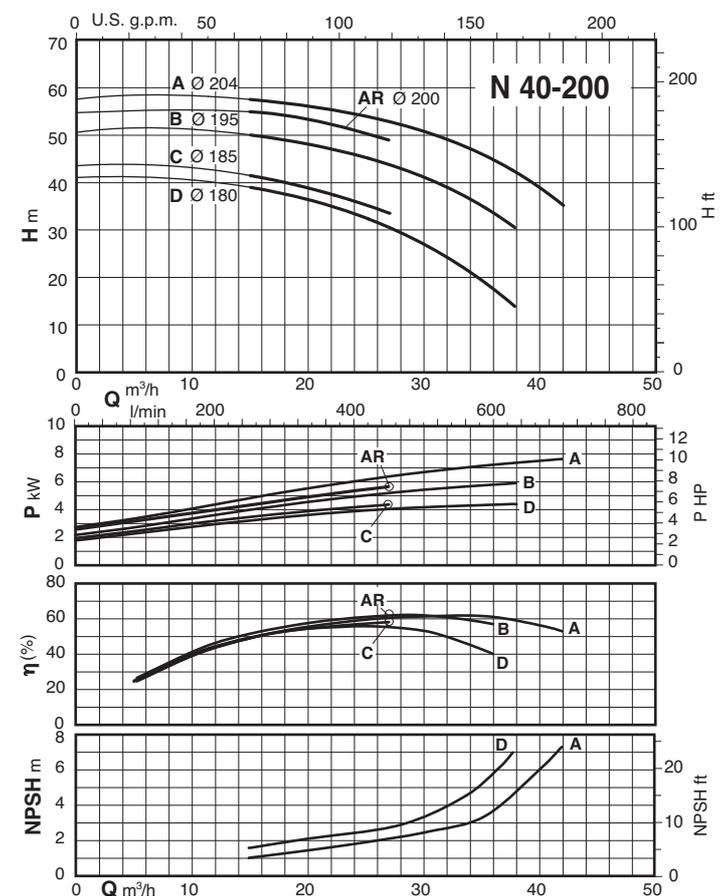
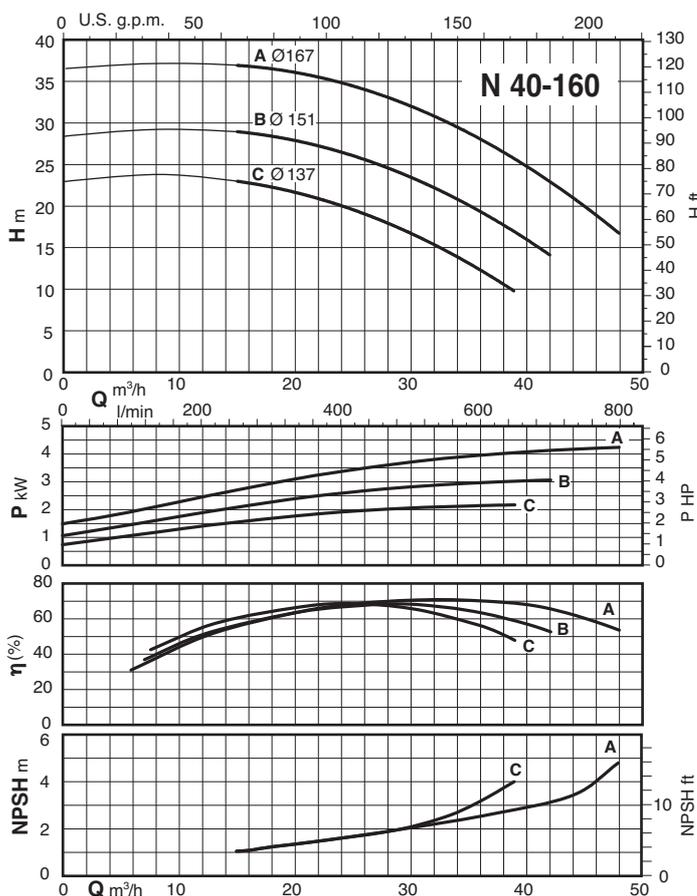
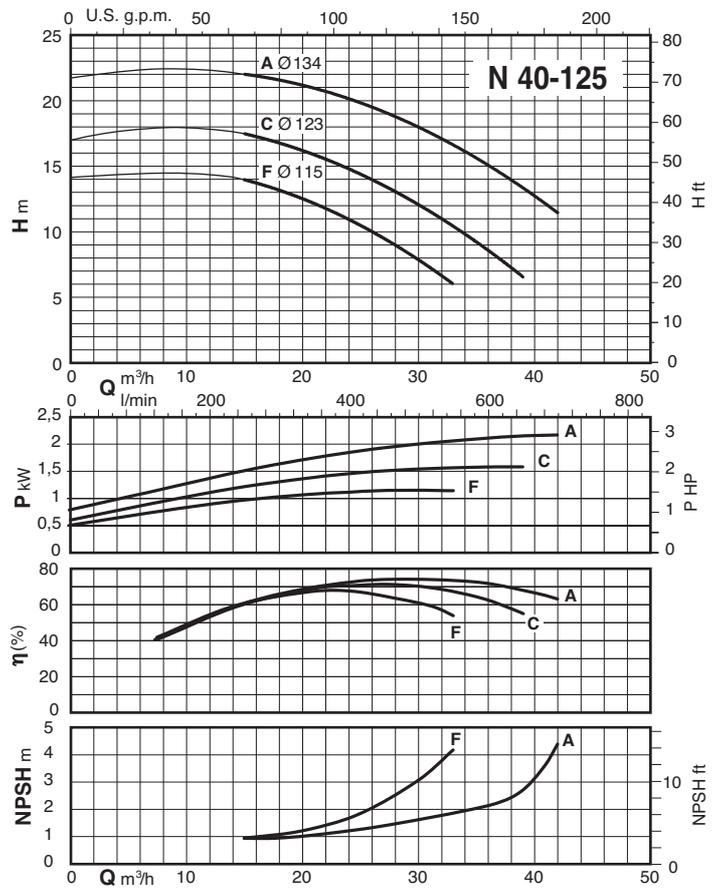
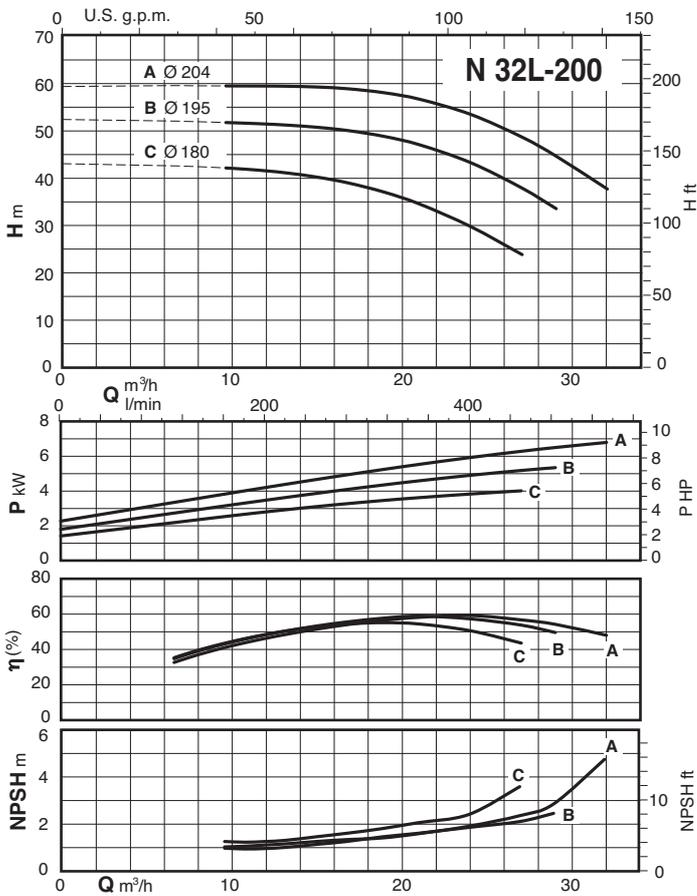

Характеристические кривые $n \approx 2900$ об./мин.

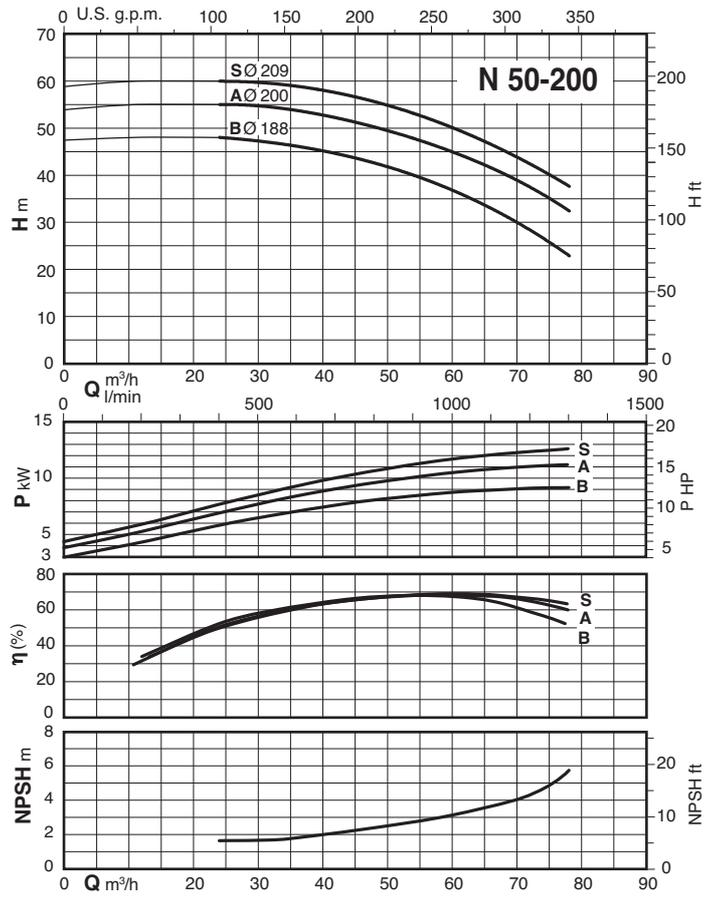
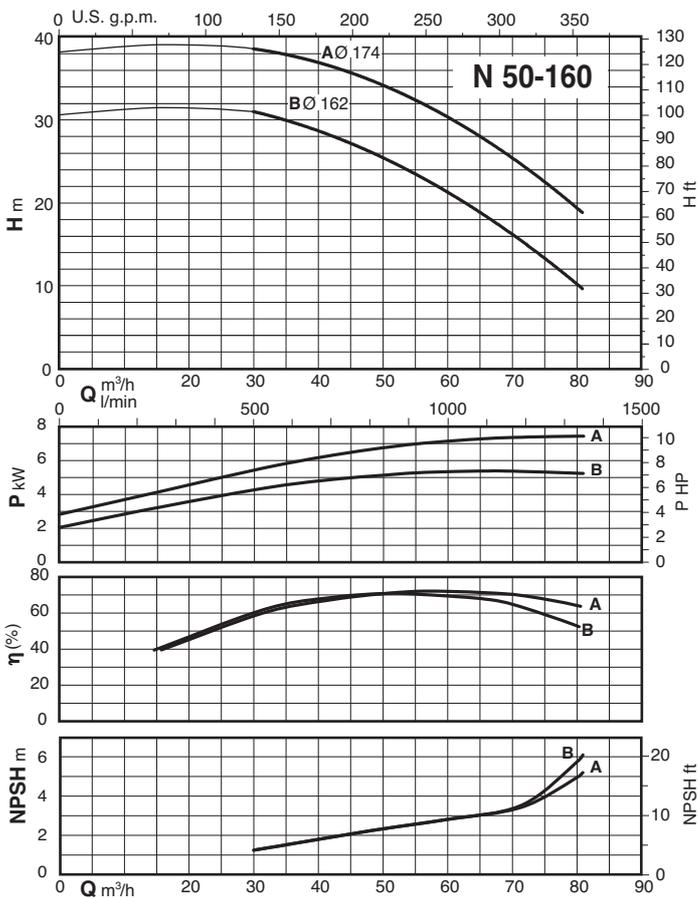
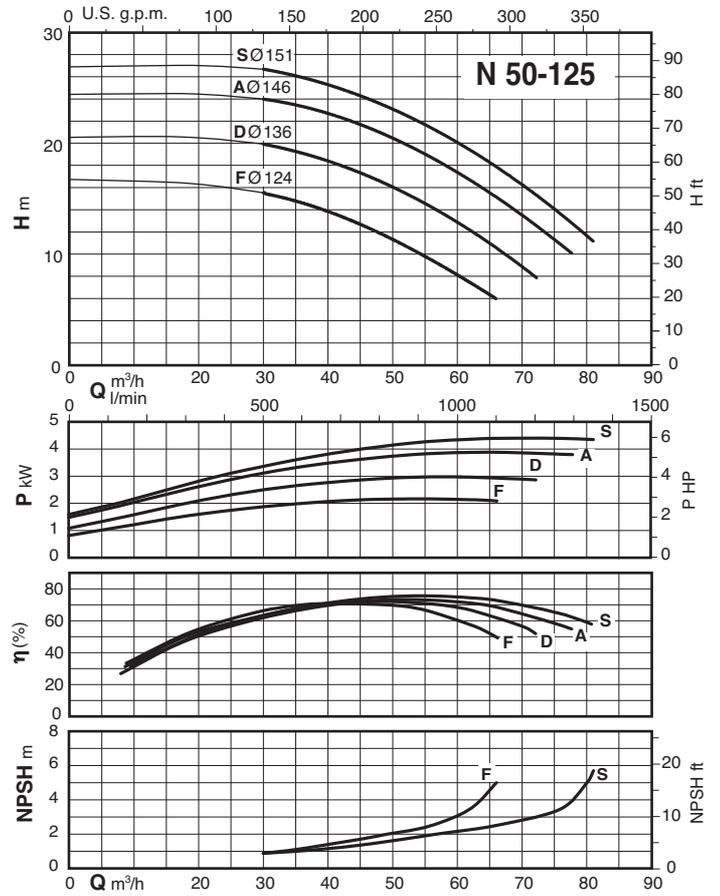
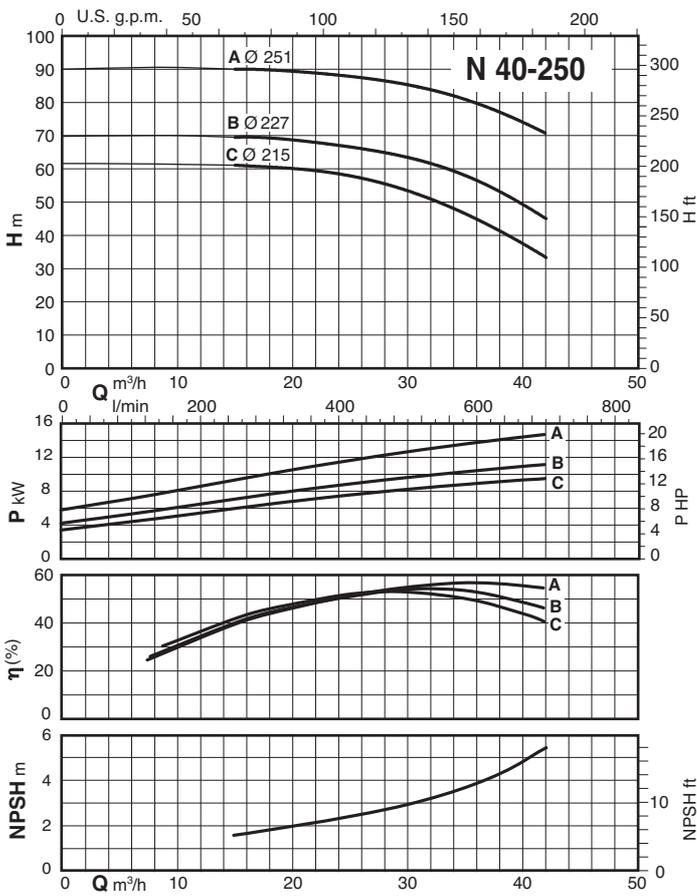



Характеристические кривые $n \approx 2900$ об./мин.

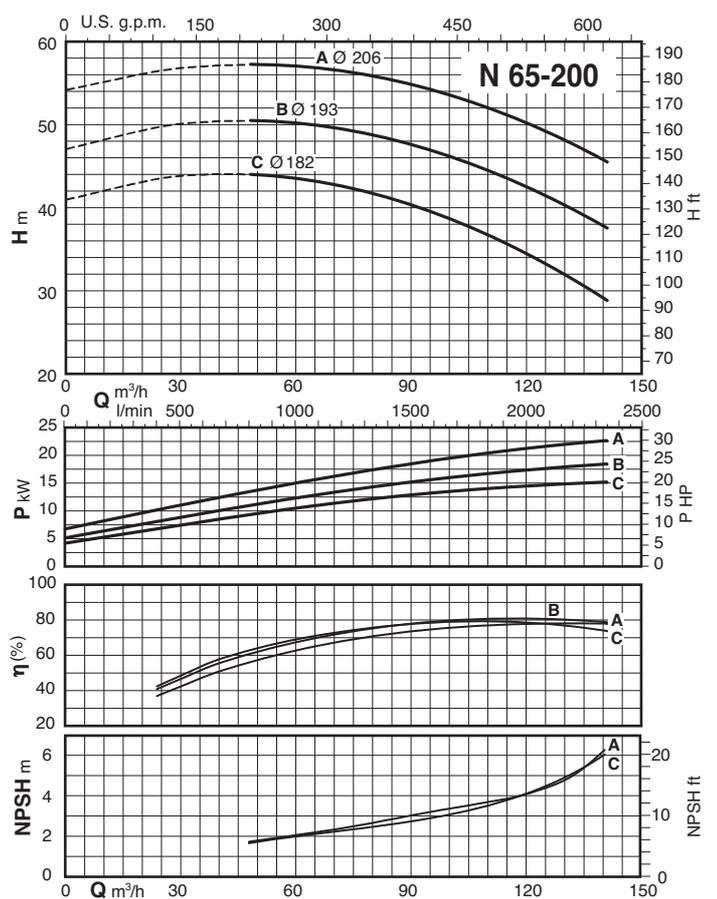
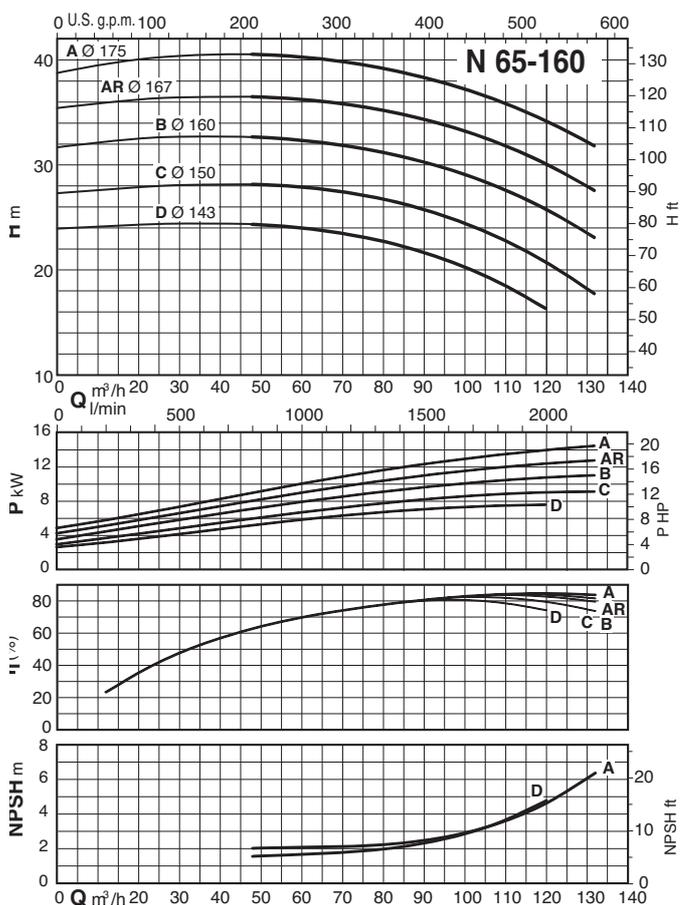
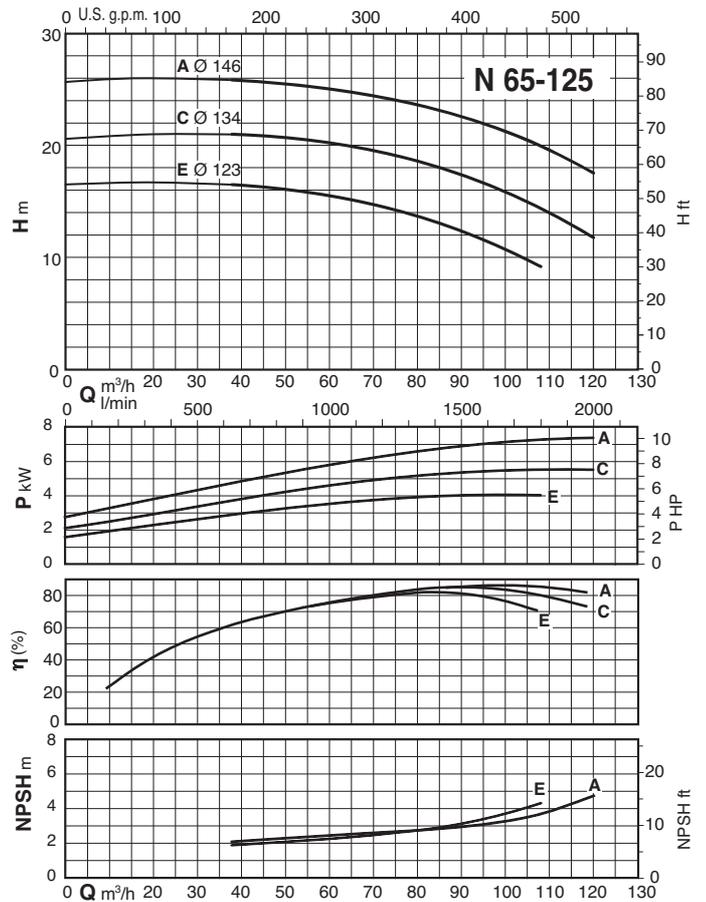
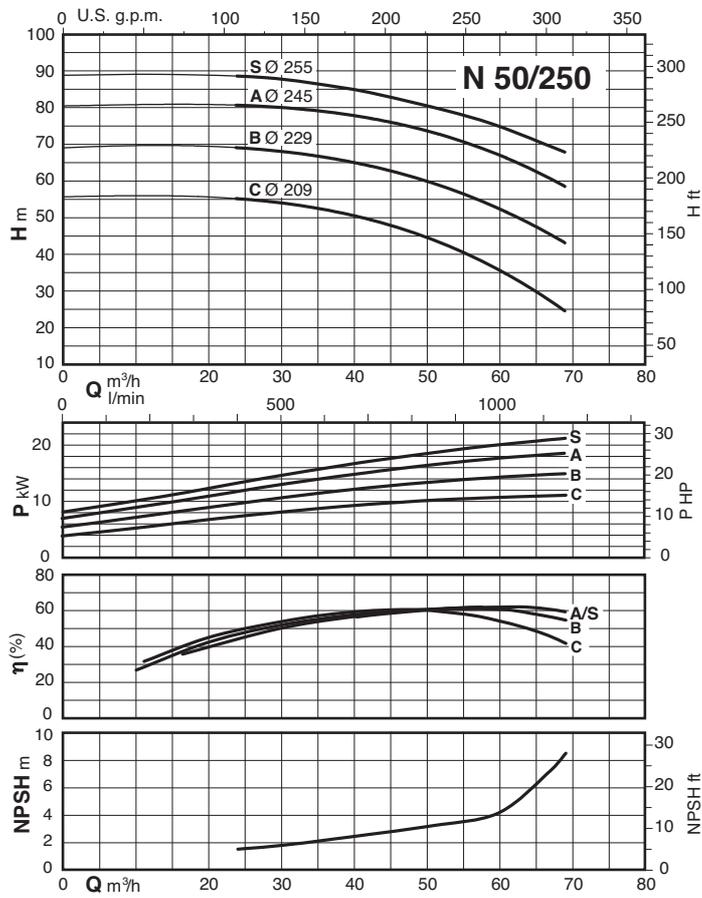

Характеристические кривые $n \approx 2900$ об./мин.

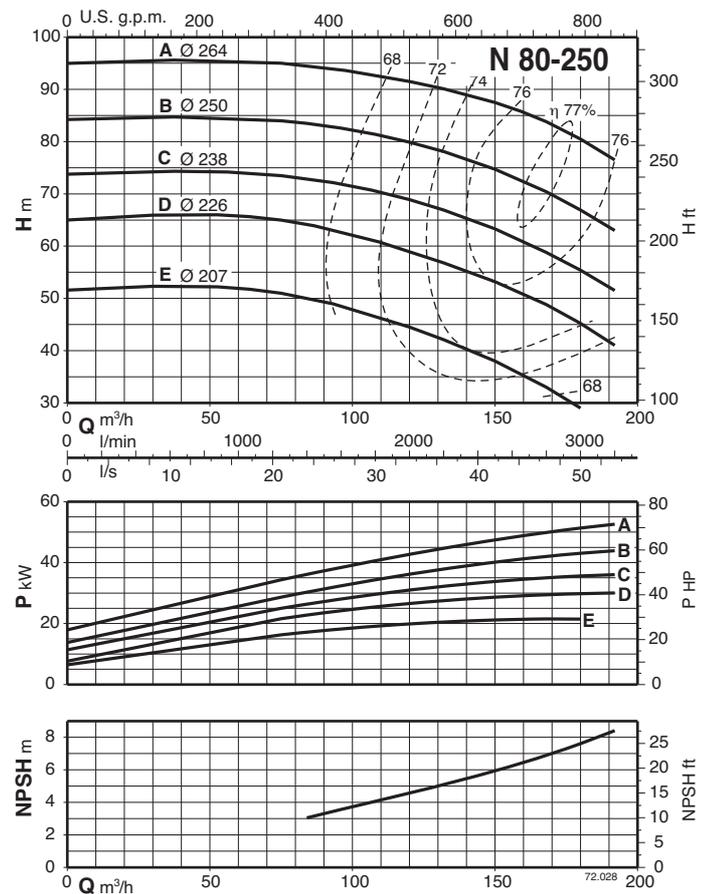
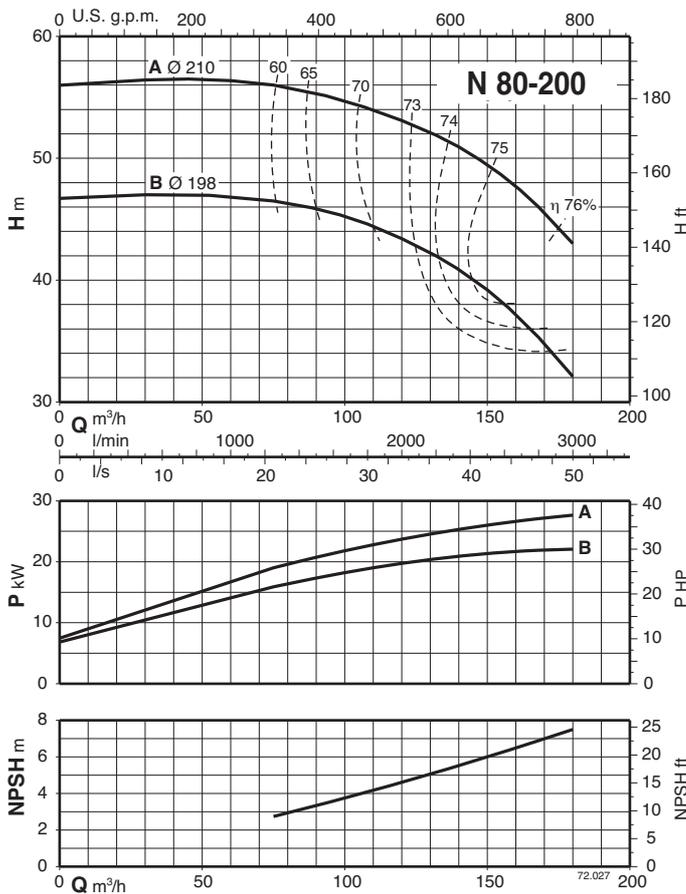
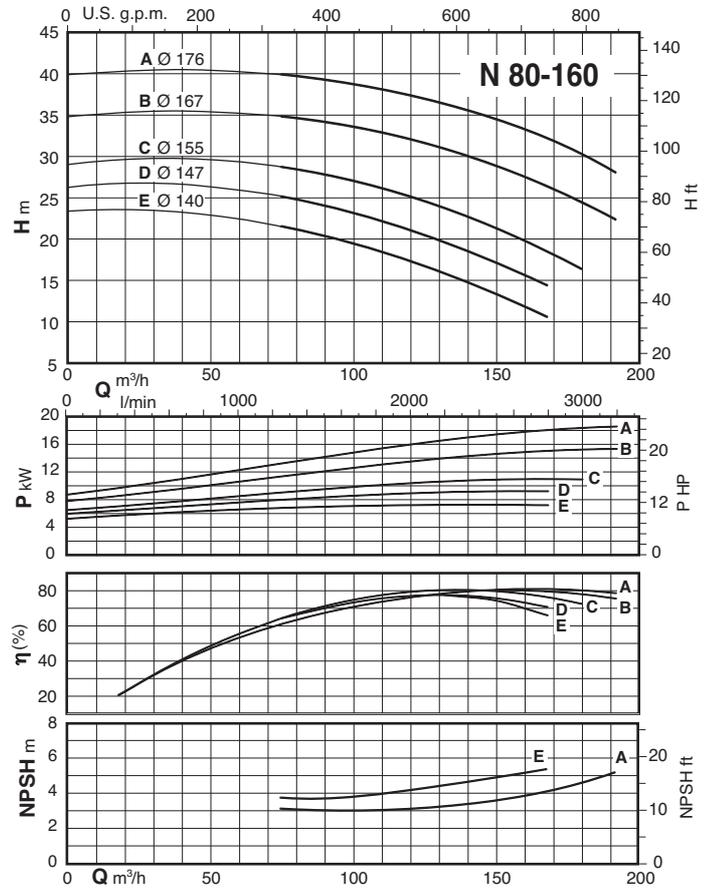
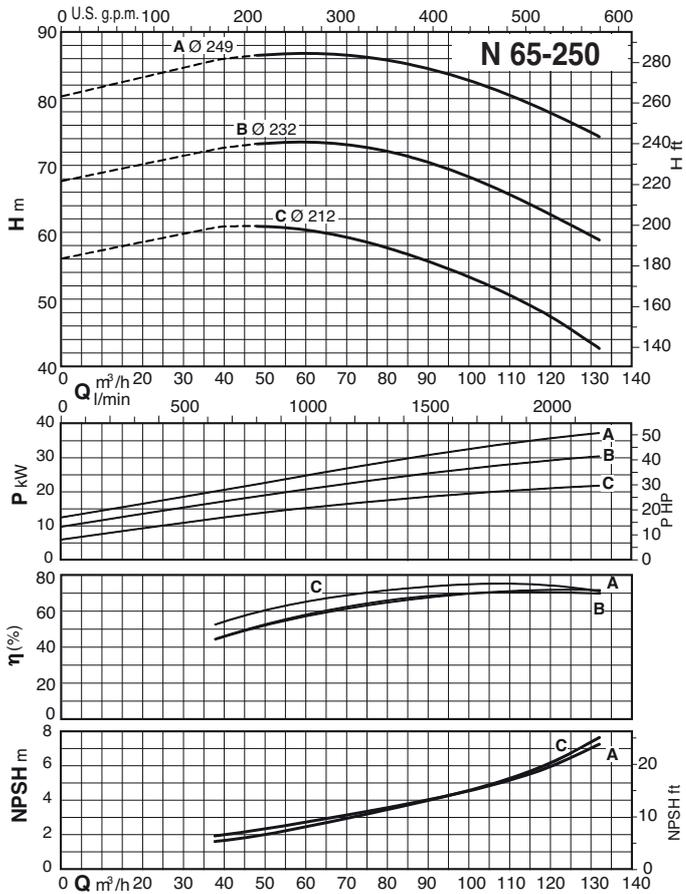

Характеристические кривые $n \approx 2900$ об./мин.

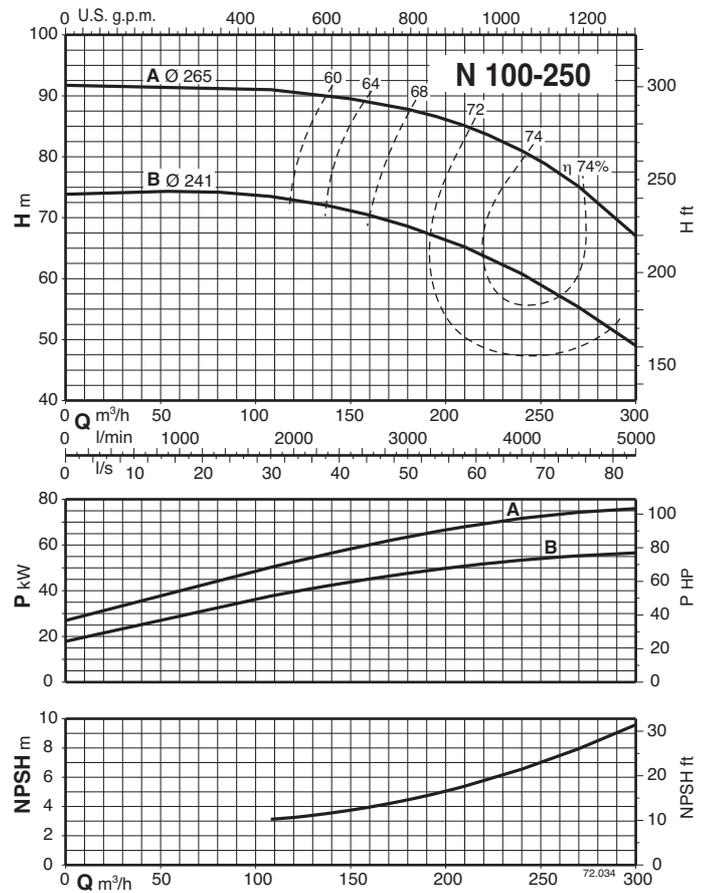
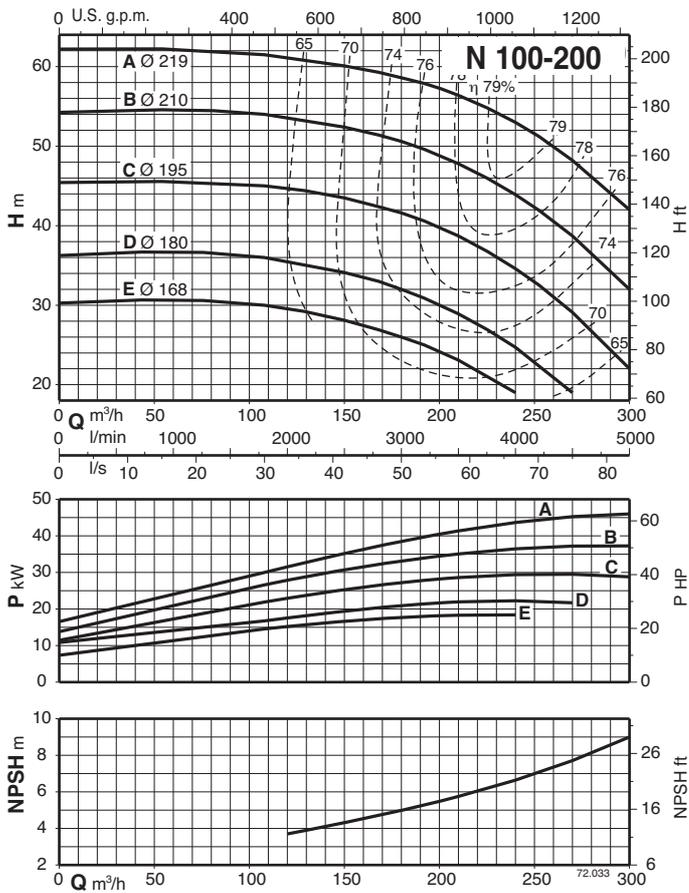

Характеристические кривые $n \approx 1450$ об./мин.

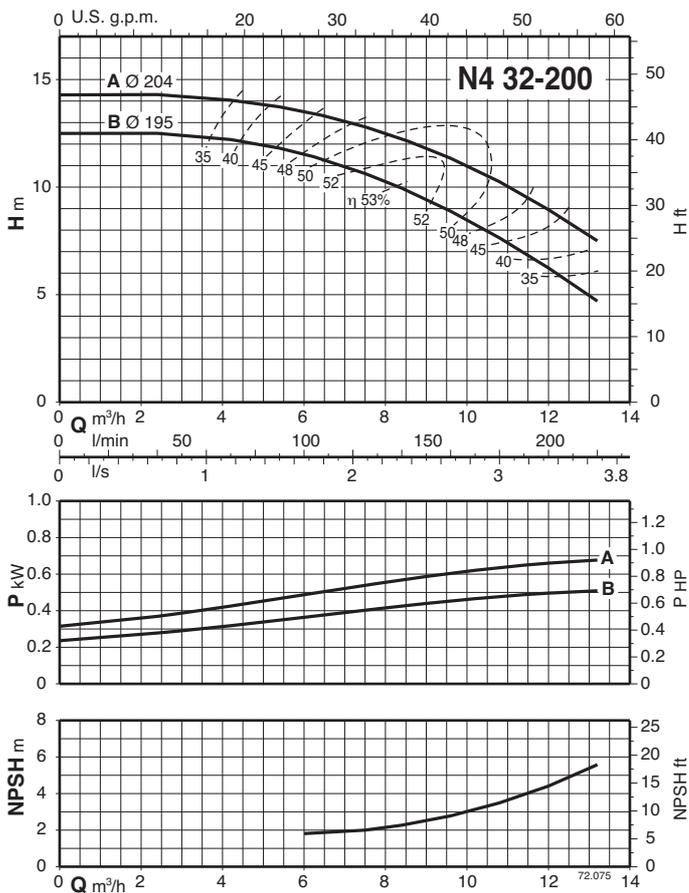
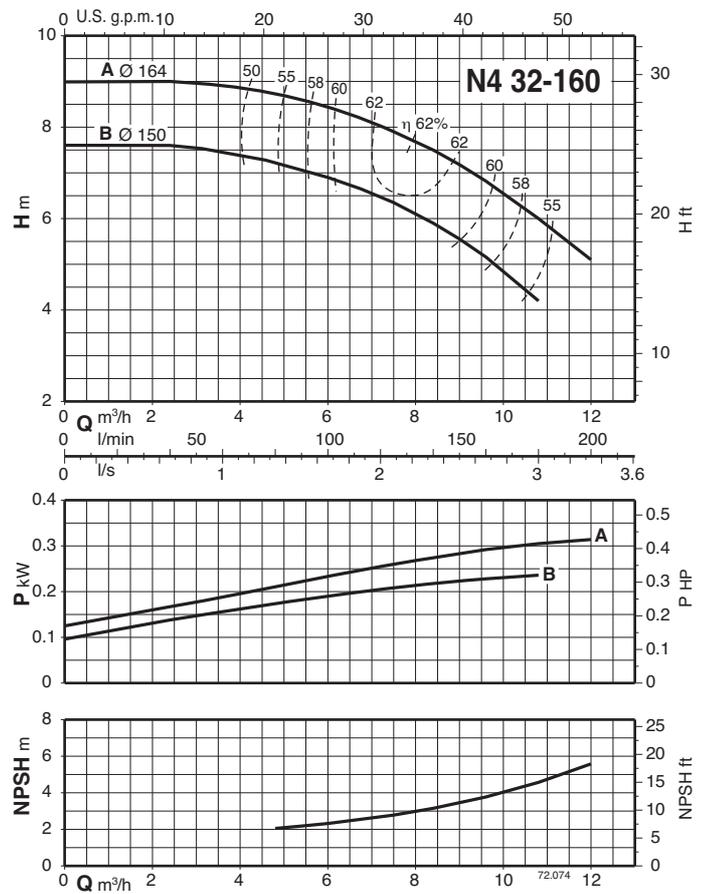
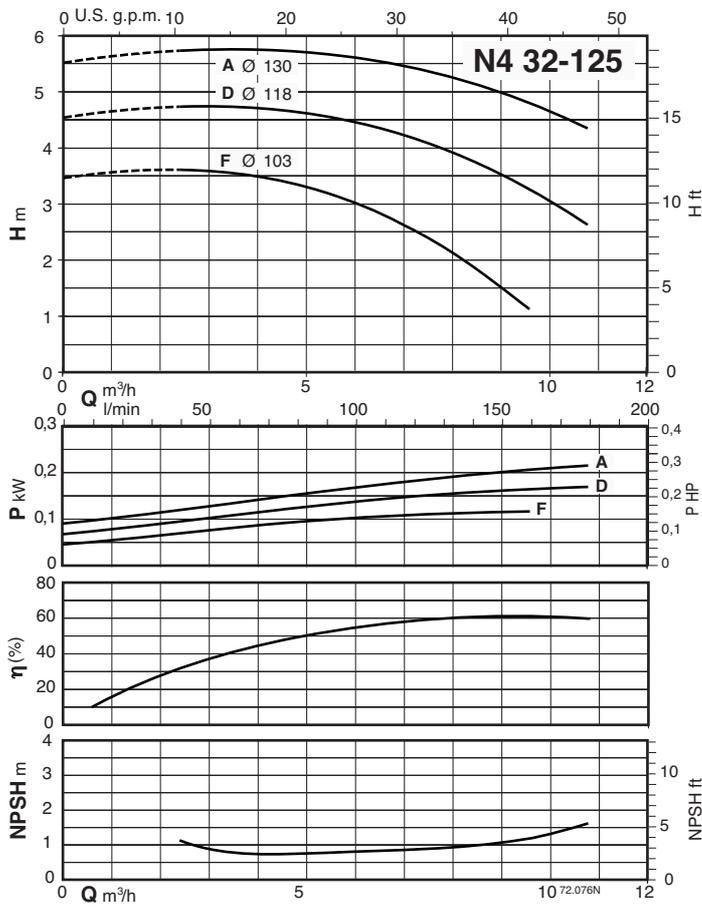

Характеристические кривые $n \approx 1450$ об./мин.

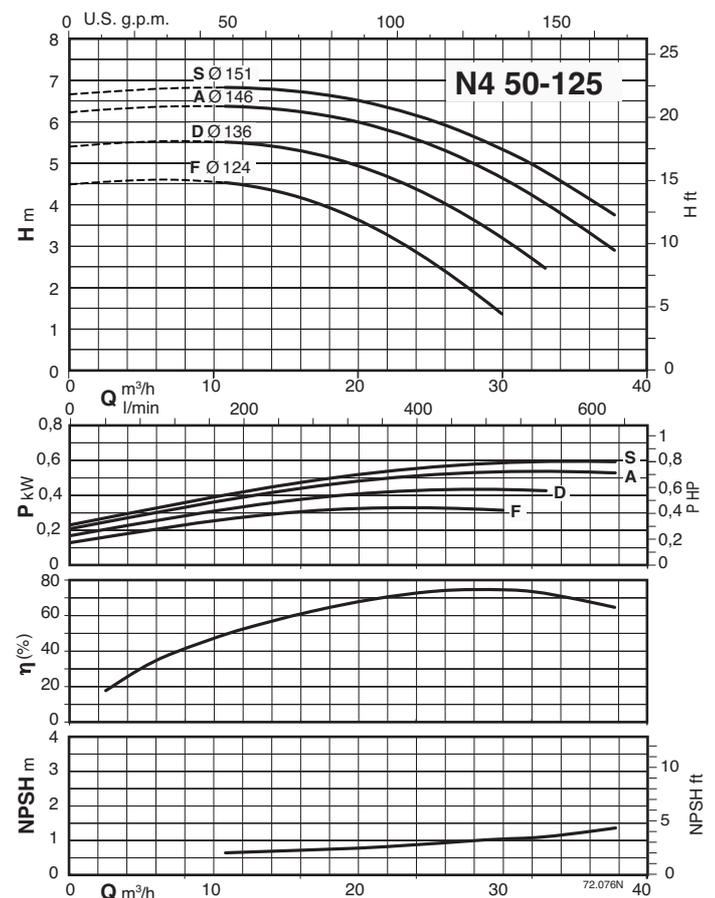
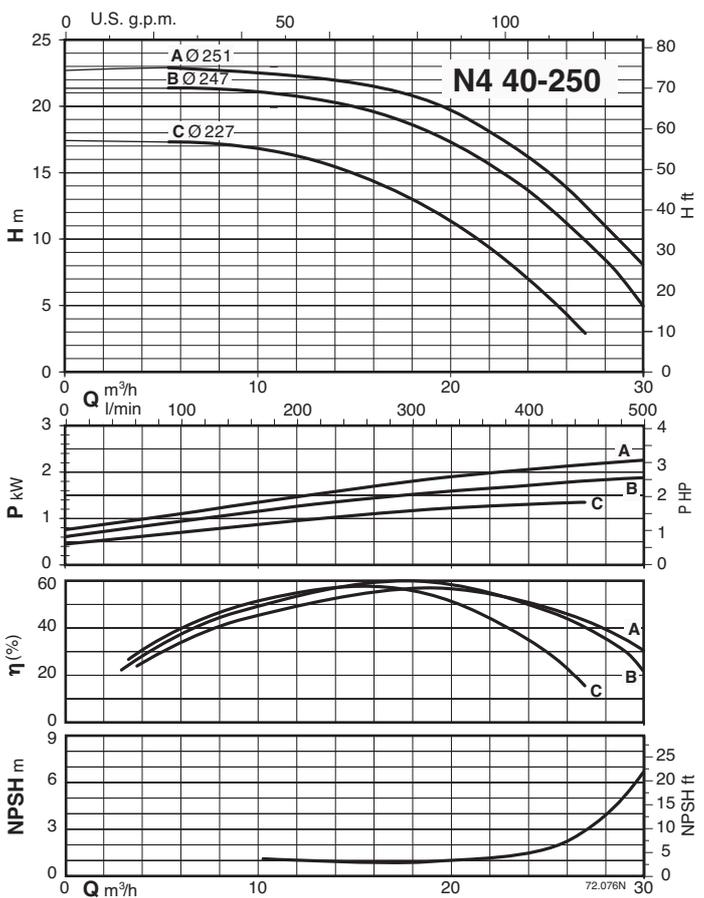
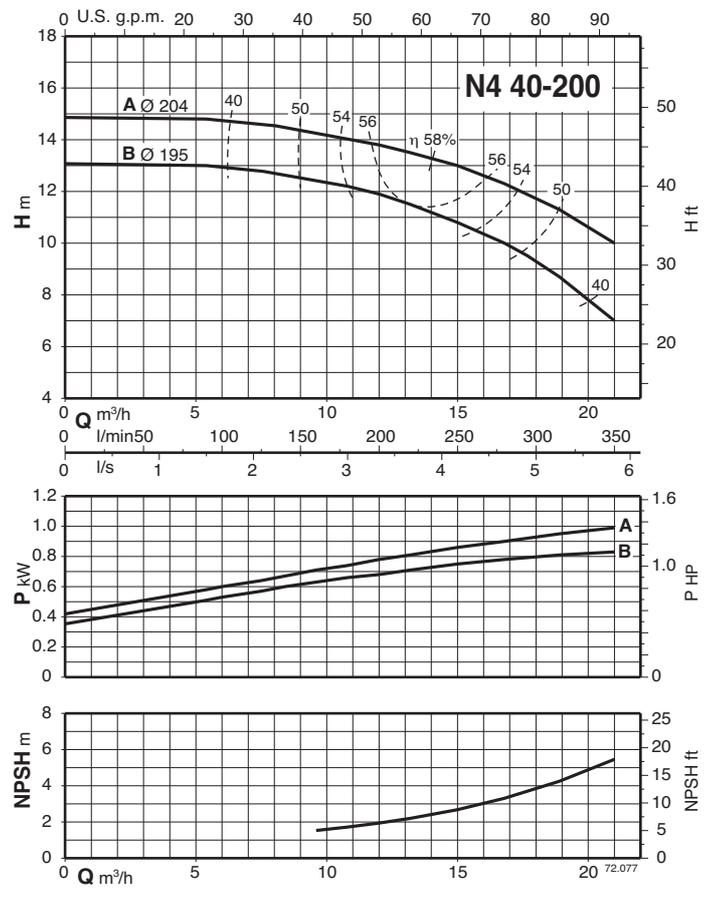
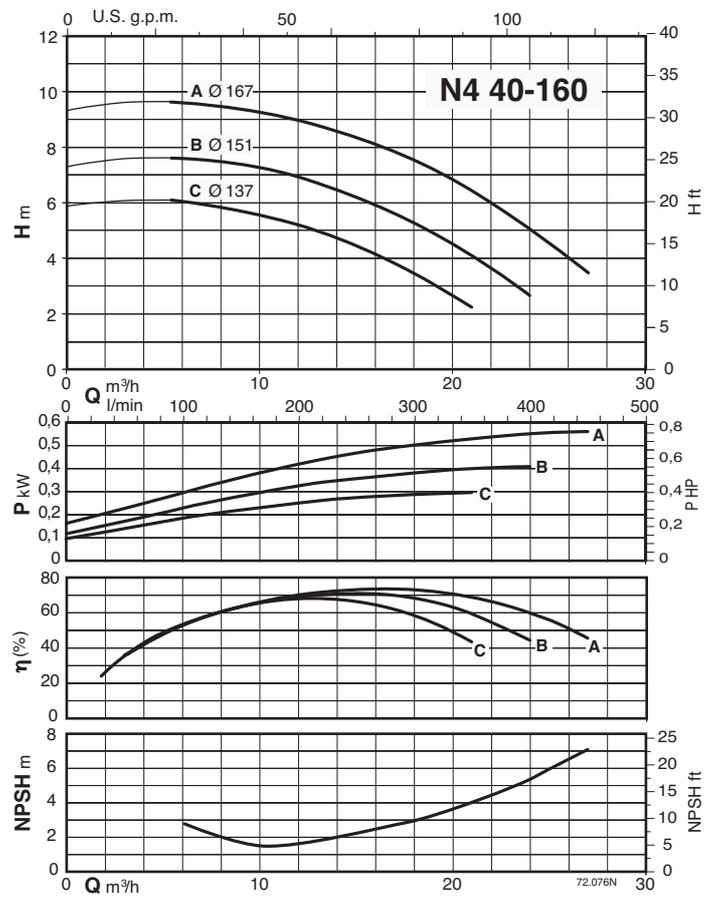

Характеристические кривые $n \approx 1450$ об./мин.

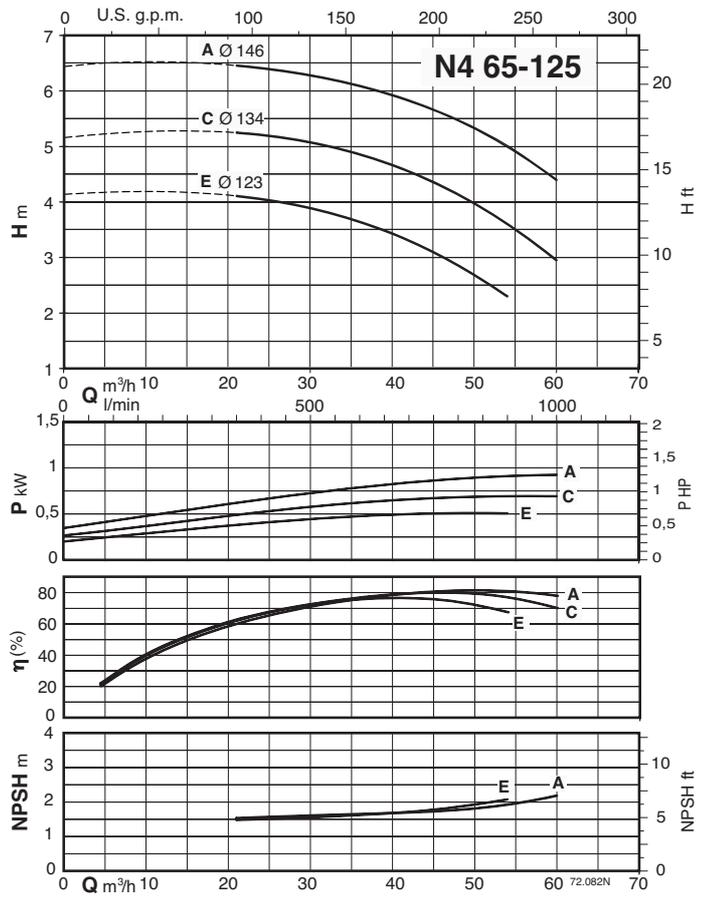
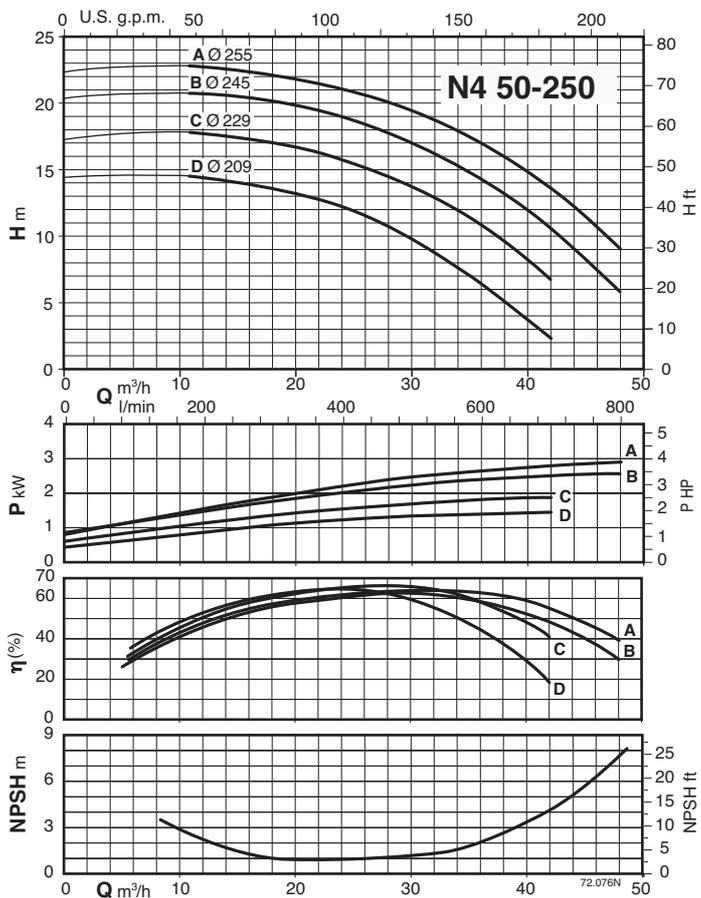
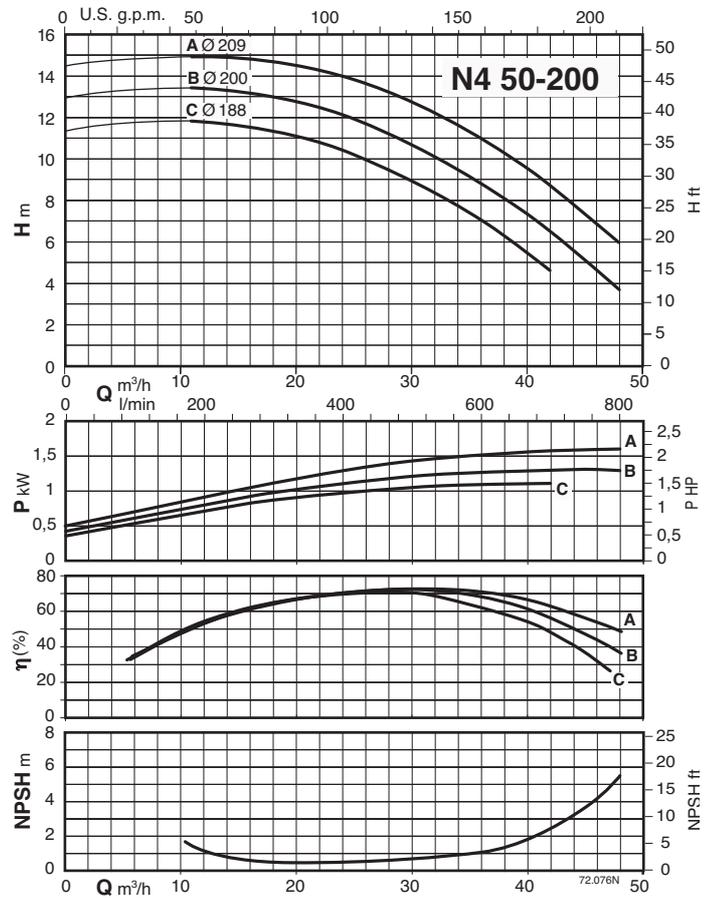
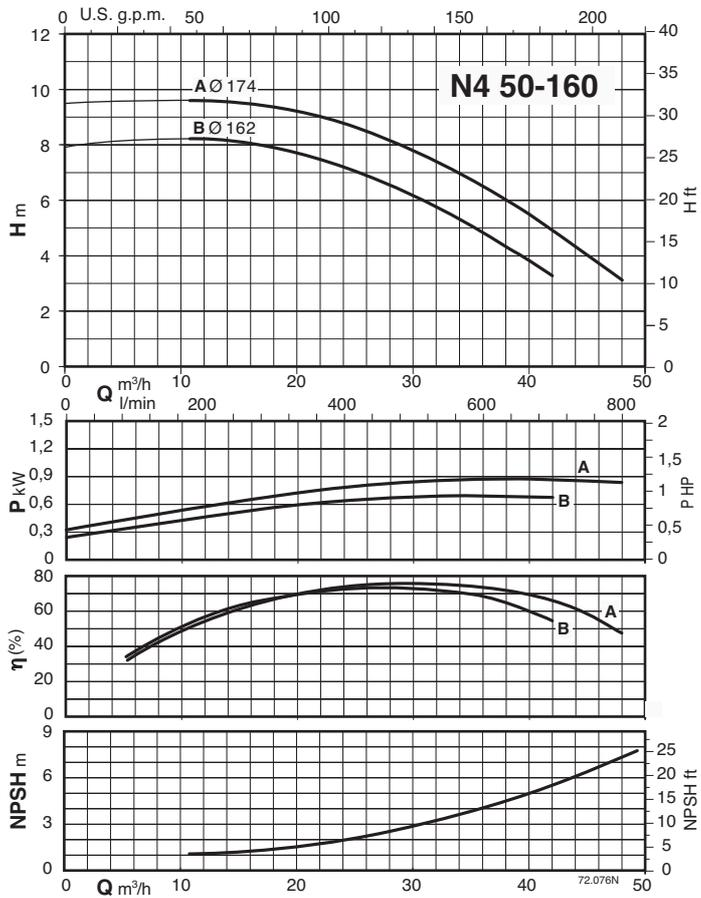

Характеристические кривые $n \approx 1450$ об./мин.

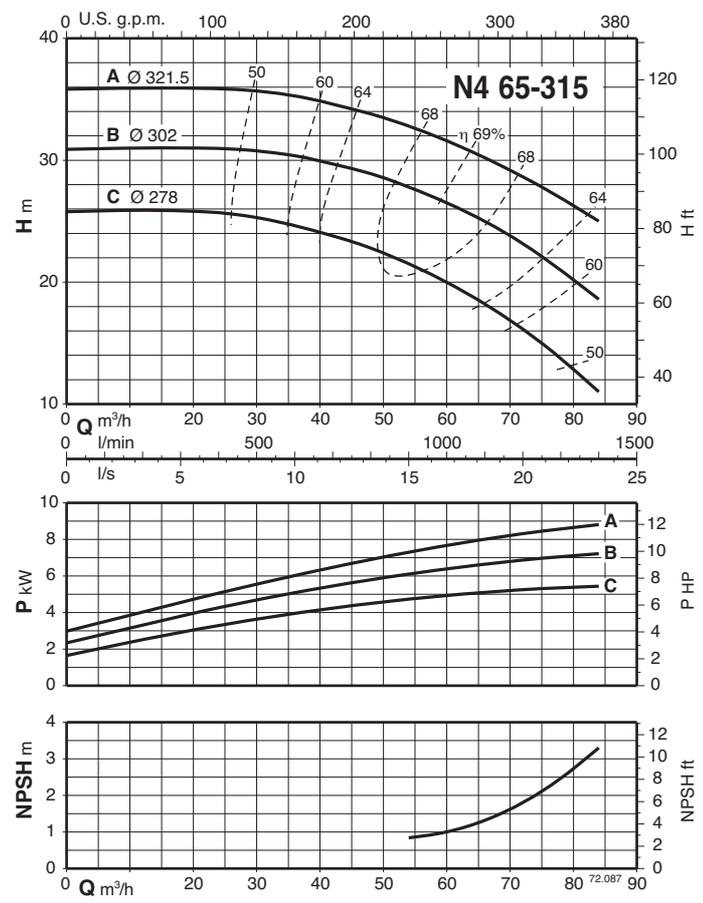
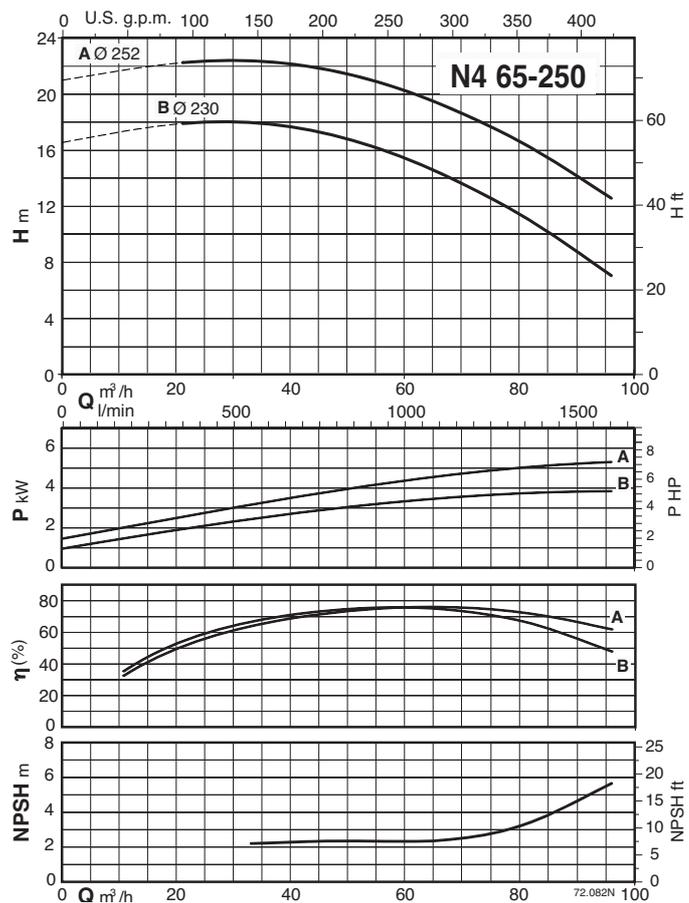
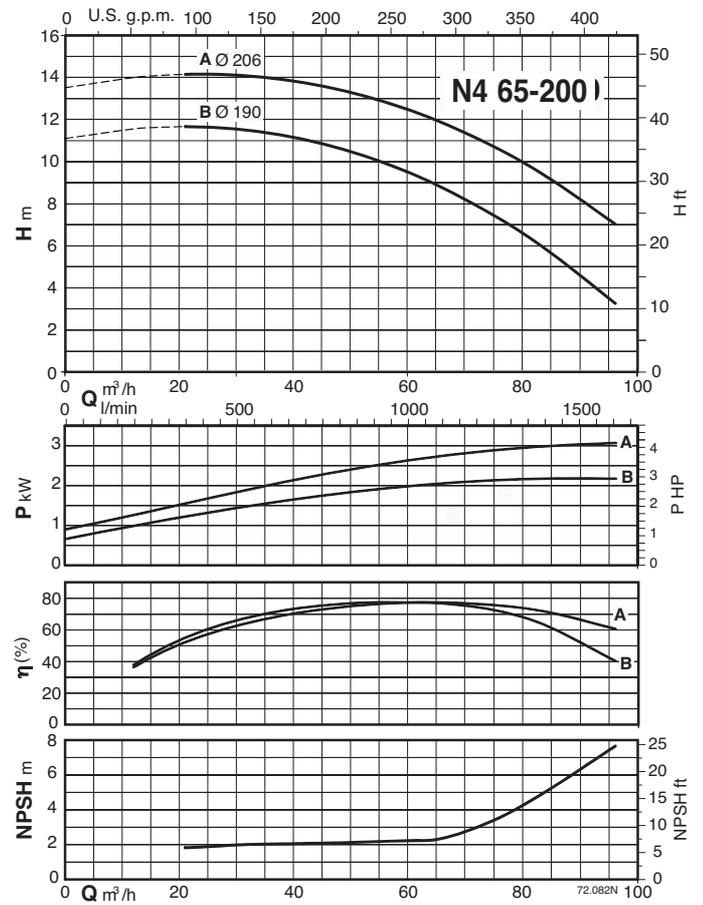
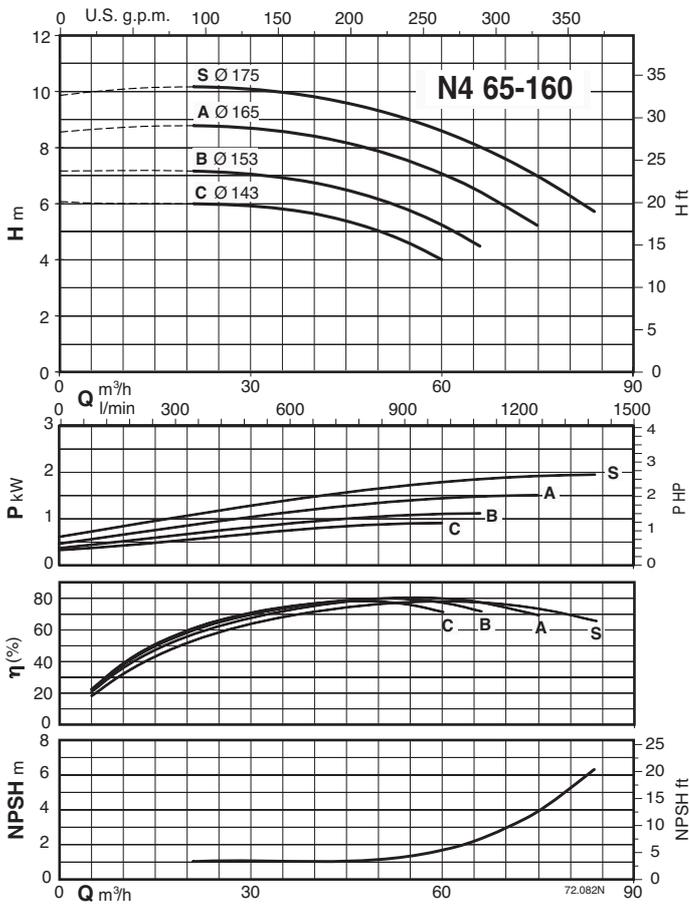

Характеристические кривые $n \approx 1450$ об./мин.

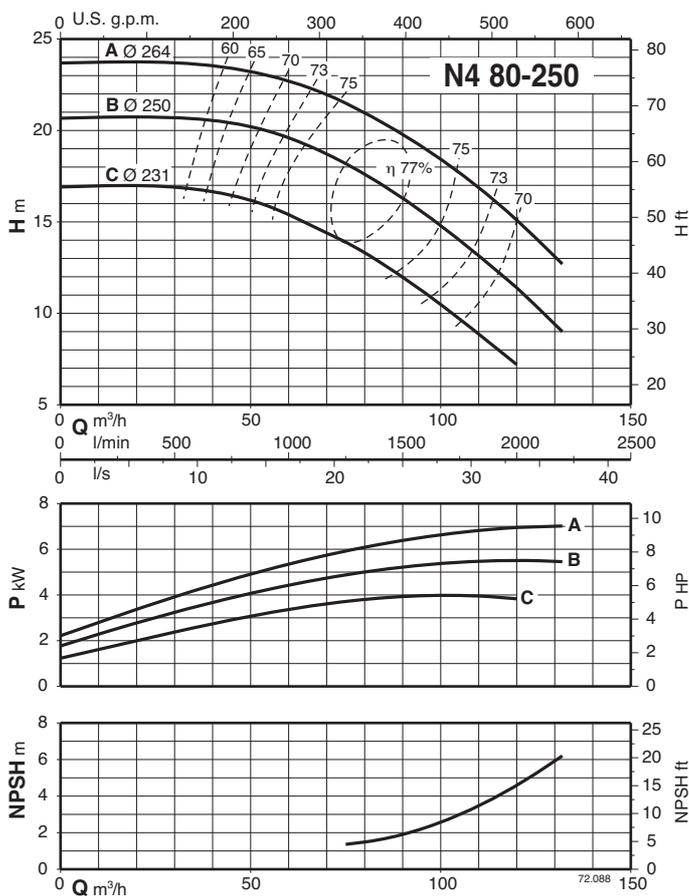
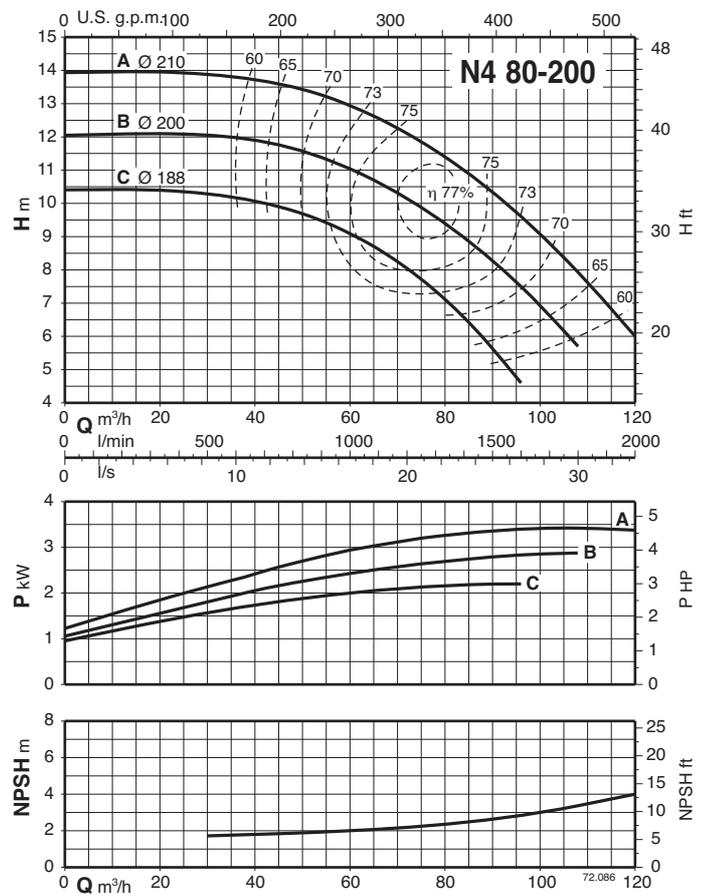
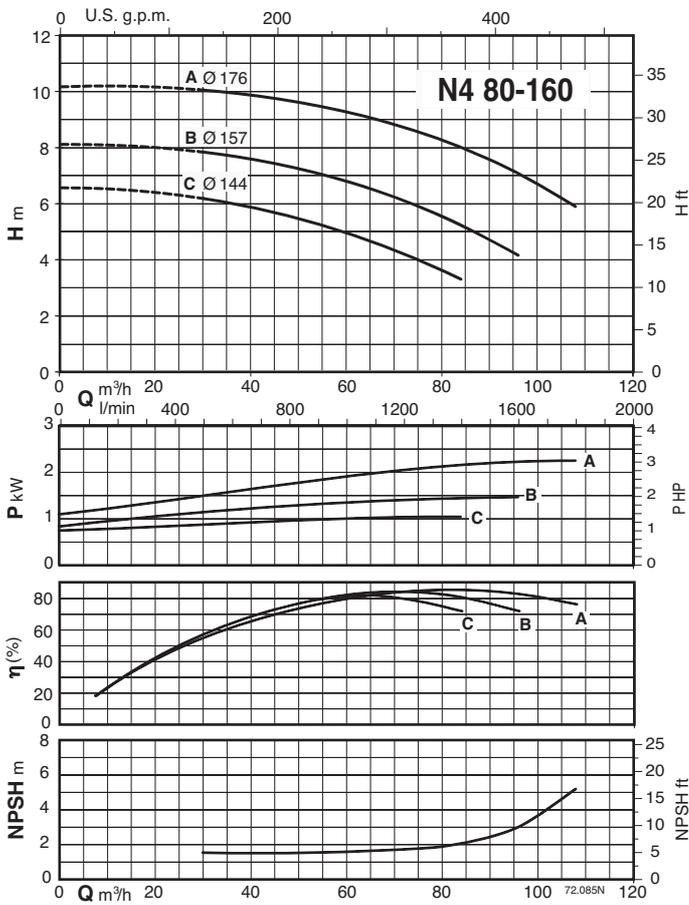

Характеристические кривые $n \approx 1450$ об./мин.

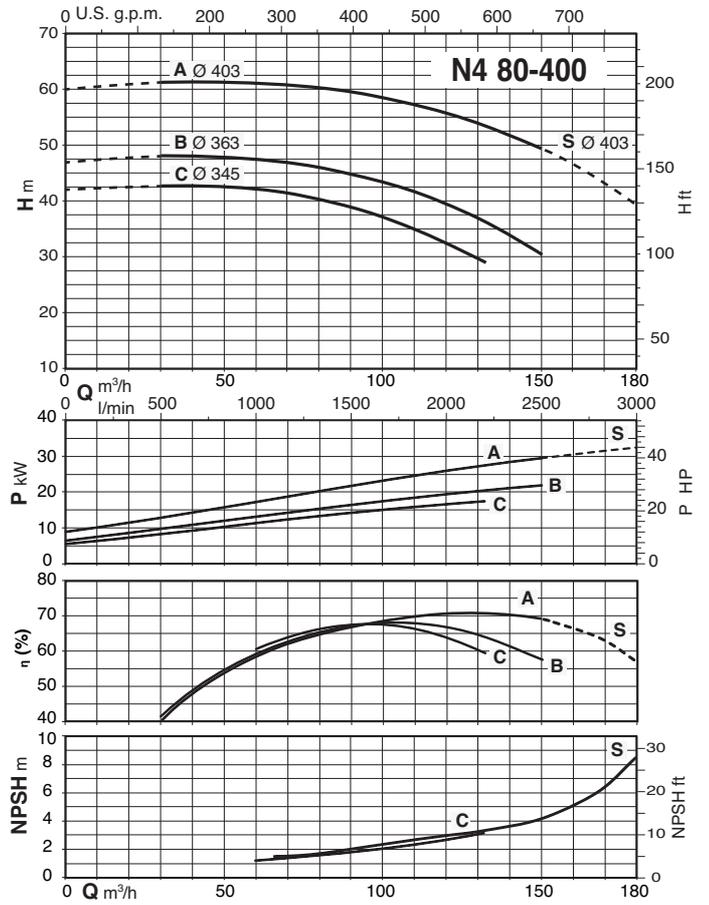
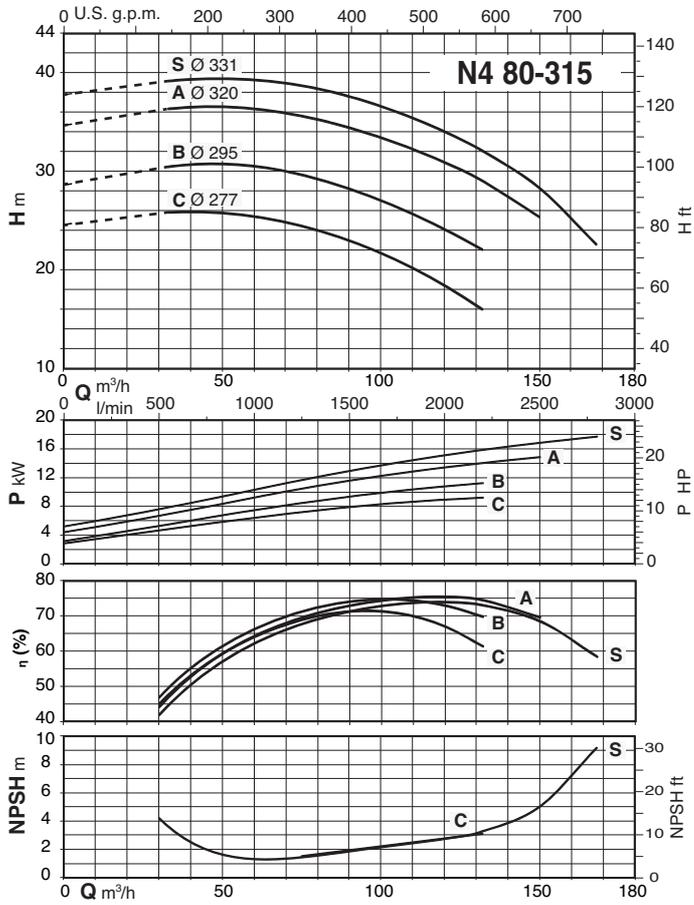

Характеристические кривые $n \approx 1450$ об./мин.

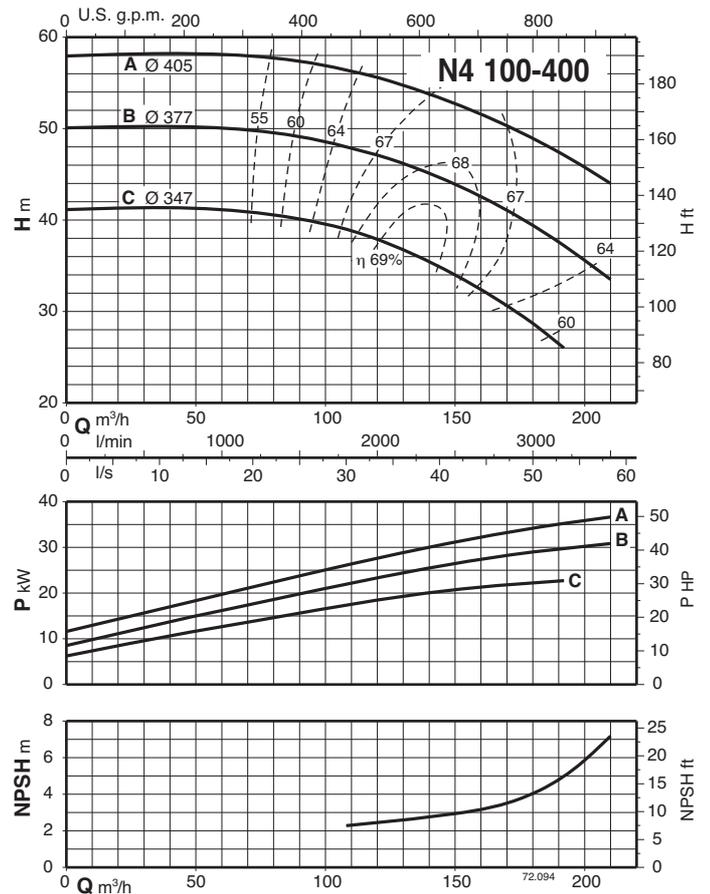
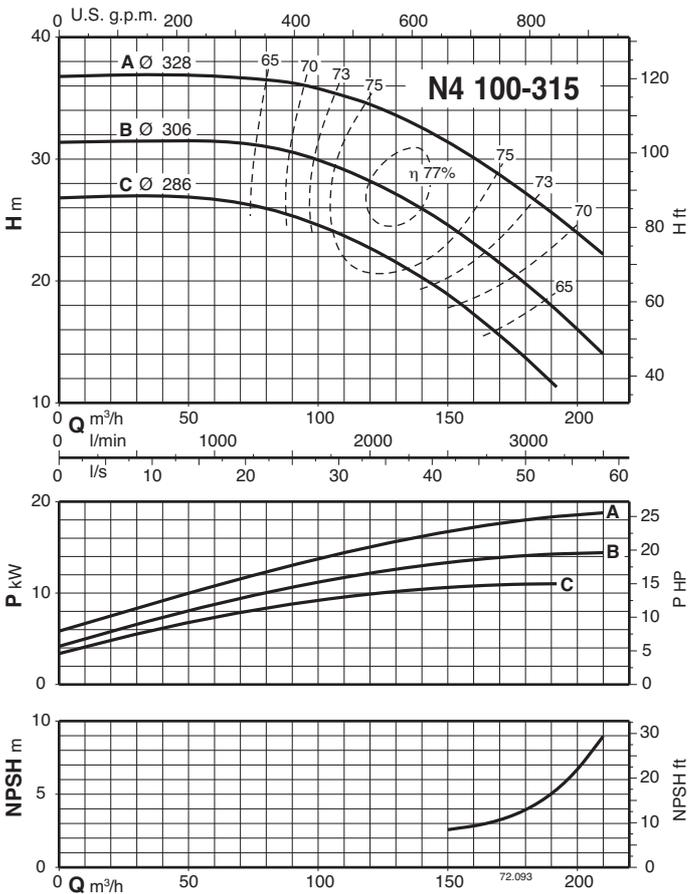
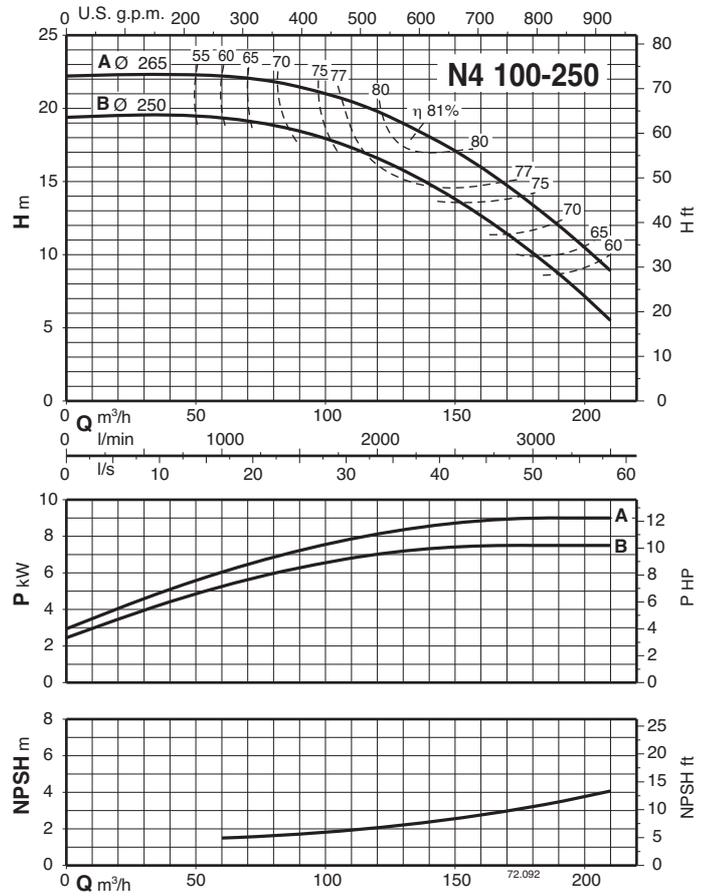
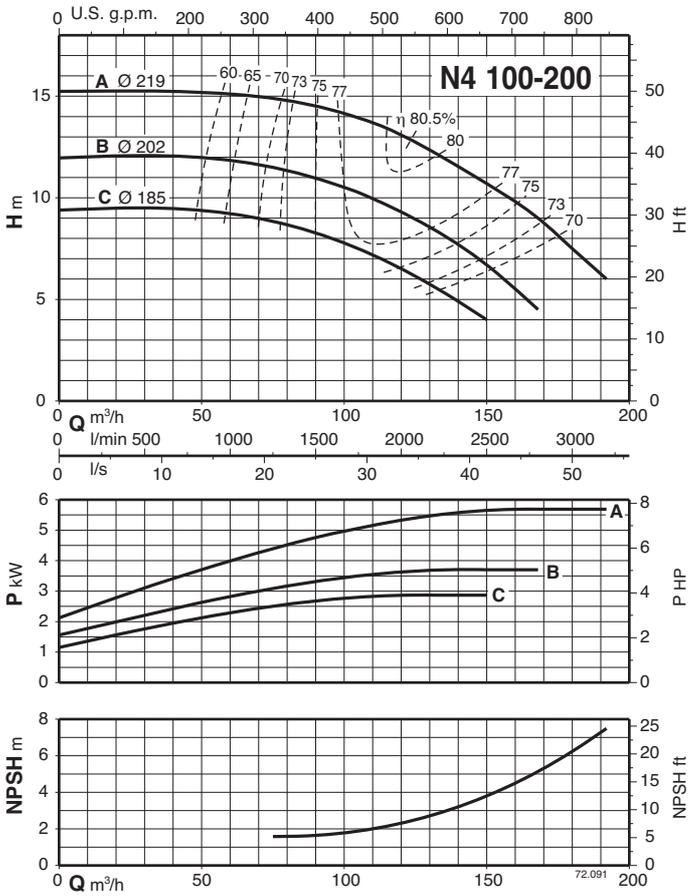

Характеристические кривые $n \approx 1450$ об./мин.

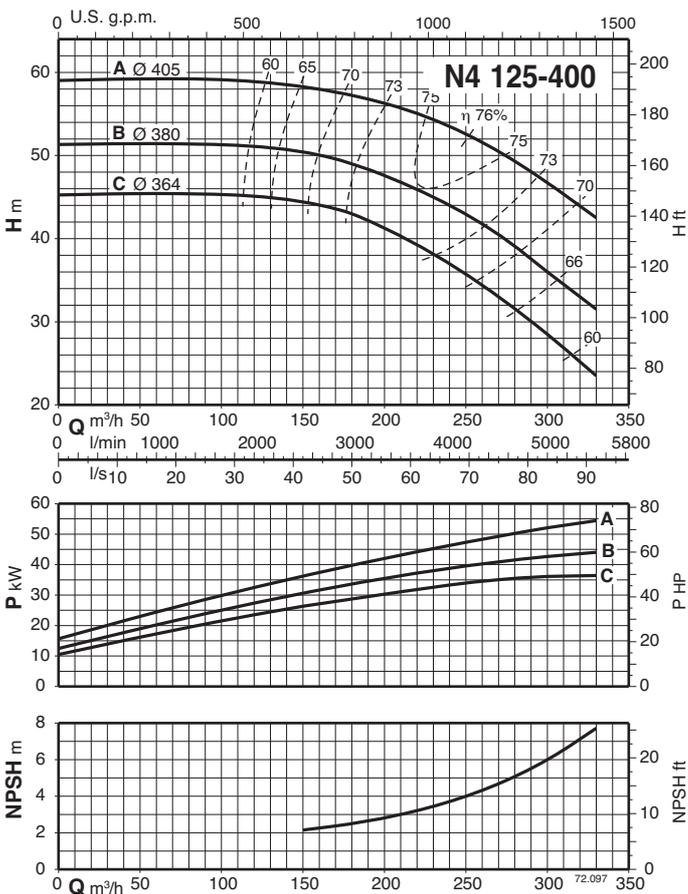
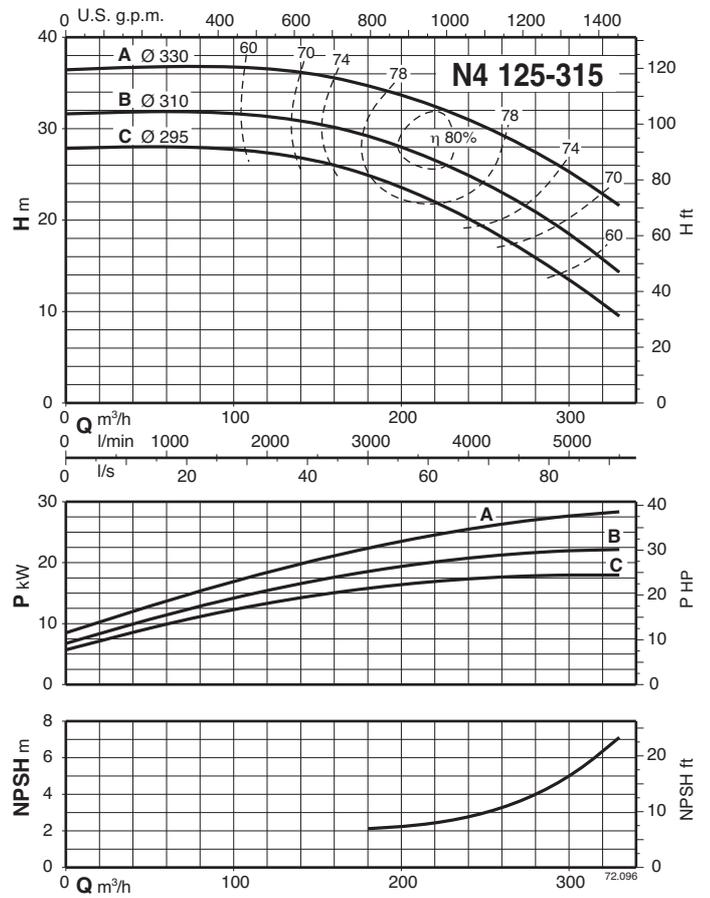
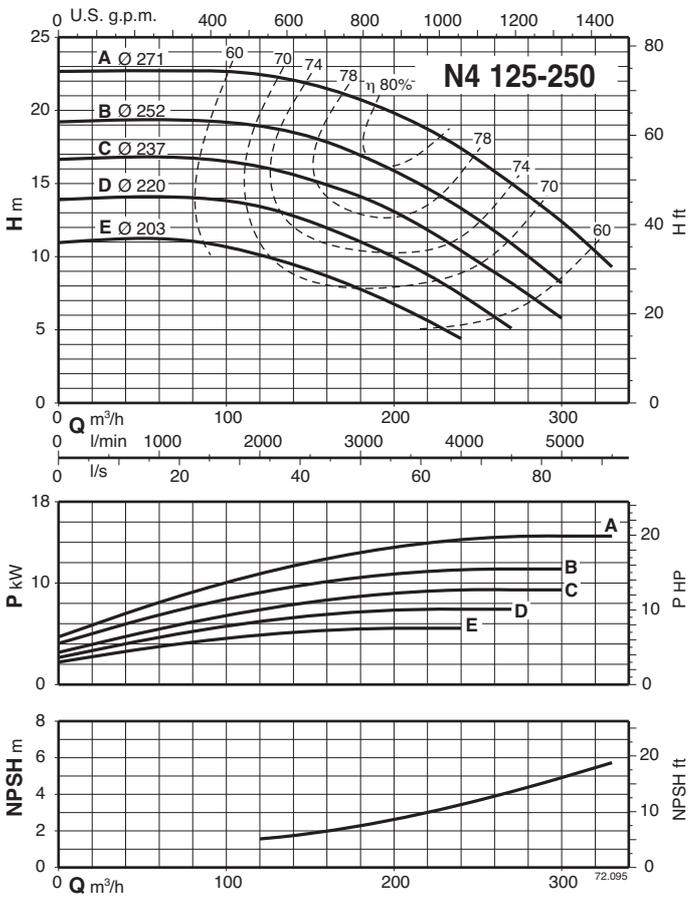

Характеристические кривые $n \approx 1450$ об./мин.

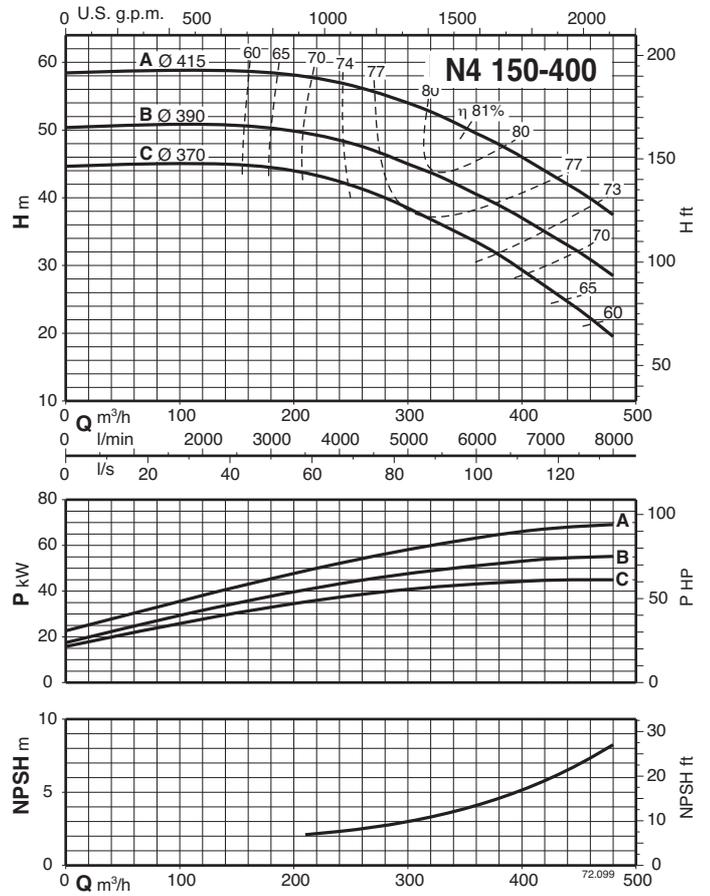
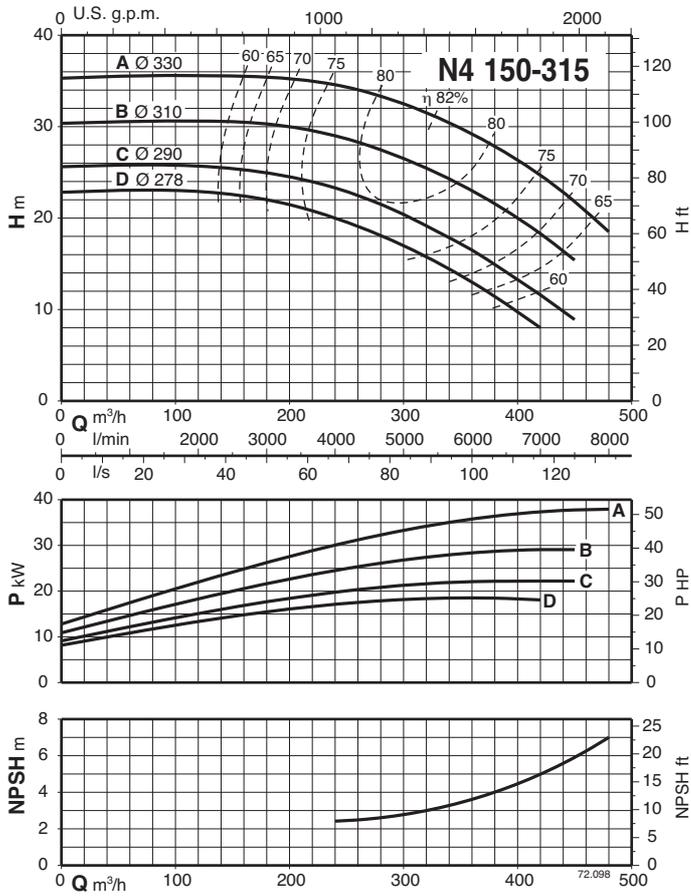

Взаимозаменяемость компонентов

ТИП	Несущий корпус			Вал насоса					Подшипники				Уплотнение на валу		
	1	2	3	I	II	III	IV	V	6207 Z 6306 Z	6207 Z 3306	6309 Z 3309	6311 Z 3311	Ø 32	Ø 40	Ø 50
N,N4 32-125	●			●					●				●		
N,N4 32-160	●				●				●				●		
N,N4 32-200	●				●				●				●		
N,N4 40-125	●				●				●				●		
N,N4 40-160	●				●				●				●		
N,N4 40-200C	●				●				●				●		
N,N4 40-200A-AR-B	●					●				●			●		
N,N4 40-250	●					●				●			●		
N,N4 50-125	●				●				●				●		
N,N4 50-160	●					●				●			●		
N,N4 50-200	●					●				●			●		
N,N4 50-250	●					●				●			●		
N 50 M	●					●				●			●		
N,N4 65-125E	●				●				●				●		
N,N4 65-125A-C	●					●				●			●		
N,N4 65-160	●					●				●			●		
N,N4 65-200	●					●				●			●		
N,N4 65-250		●					●				●			●	
N4 65-315		●					●				●			●	
N,N4 80-160	●					●				●			●		
N,N4 80-200		●					●				●			●	
N,N4 80-250		●					●				●			●	
N4 80-315		●					●				●			●	
N4 80-400			●					●				●			●
N,N4 100-200		●					●				●			●	
N,N4 100-250		●					●				●			●	
N4 100-315		●					●				●			●	
N4 100-400			●					●				●			●
N4 125-250		●					●				●			●	
N4 125-315			●					●				●			●
N4 125-400			●					●				●			●
N4 150-315			●					●				●			●
N4 150-400			●					●				●			●

Максимально допустимая частота вращения

3600 об./мин.			3000 об./мин.			1800 об./мин.		
32-125	32-160	32-200						
40-125	40-160	40-200			40-250			
50-125	50-160	50-200			50-250			
					50 M			
65-125	65-160			65-200	65-250		65-315	
		80-200	80-160		80-250		80-315	80-400
		100-200			100-250		100-315	100-400
							125-250	125-315
							125-400	125-400
							150-315	150-400

Всасывающая труба: рекомендуемый минимальный внутренний диаметр (DN) для различного расхода (Q)

Резьбовая труба	mm	G 2		G 2 1/2		G 3		G 4		G 5	
		50	65	80	100	125	150	200	250	300	
DN	mm	50	65	80	100	125	150	200	250	300	
Q max	m³/h	10,5	19	28,8	45	75	108	215	350	508	

Размеры и вес

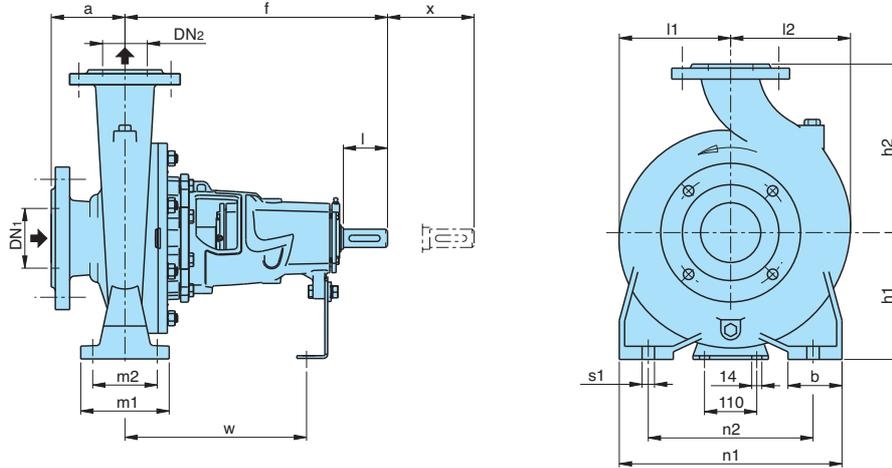

Торец вала согласно стандарта ISO 775 Шпонка по стандарту UNI 6604

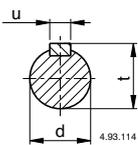

MM			
d	l	u	t
24 j6	50	8	27
32 k6	80	10	35
42 k6	110	12	45

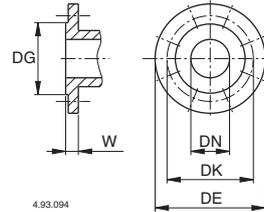

Фланцы PN 10, EN 1092-2

MM						
DN	DG	DK	DE	Отверстия		g2
				N°	Ø	
32	76	100	140	4	19	18
40	84	110	150	4	19	18
50	99	125	165	4	19	20
65	118	145	185	4	19	20
80	132	160	200	8	19	22
100	156	180	220	8	19	24
125	184	210	250	8	19	24
150	211	240	285	8	23	26
200	266	295	340	8	23	30

N n = 2900 1/min
N4 n = 1450 1/min

ТИП	MM																kg		
	DN ₁	DN ₂	a	f	h ₁	h ₂	l ₁	l ₂	m ₁	m ₂	n ₁	n ₂	b	s ₁	d	w	x	B-N	N4
B-N, B-N4 - N, N4 32-125	50	32	80	360	112	140	93	97	100	70	190	140	50	14	24	260	100	30	26,5
B-N, B-N4 - N, N4 32-160					132	160	120	120										37	33
B-N, B-N4 - N, N4 32-200					160	180	140	140										44	38,4
B-N, B-N4 - N, N4 32L-160					132	160	120	120										35,8	33,2
B-N, B-N4 - N, N4 32L-200					160	180	140	140			265	212						43,8	40
B-N, B-N4 - N, N4 40-125	65	40	80	360	112	140	100	113	100	70	210	160	50	14	24	260	100	32	28,4
B-N, B-N4 - N, N4 40-160					132	160	119	119										38	33,6
B-N, B-N4 - N, N4 40-200					160	180	140	140										47,1	40,4
B-N, B-N4 - N, N4 40-250					180	225	175	175										63	55
B-N, B-N4 - N, N4 50-125	65	50	100	360	132	160	121	137	100	70	240	190	50	14	24	260	100	42,4	36,5
B-N, B-N4 - N, N4 50-160					180	180	127	141										45	39,2
B-N, B-N4 - N, N4 50-200					160	200	140	153										54	47
B-N, B-N4 - N, N4 50-250					180	225	175	175										66	57,5
B-N, B-N4 - N, N4 65-125	80	65	100	360	160	180	134	155	125	95	280	212	65	14	24	260	100	48	38,7
B-N, B-N4 - N, N4 65-160					180	200	150	172										50,6	44,5
B-N, B-N4 - N, N4 65-200					180	225	155	175										55,5	50
B-N, B-N4 - N, N4 65-250					200	250	175	190										103	90
B-N4 - N4 65-315			125	470	225	280	220	220	160	120	400	315	80	18	32	340	140	149	130
B-N, B-N4 - N, N4 80-160	100	80	125	470	360	180	165	193	125	95	320	250	65	14	24	260	140	61	53
B-N, B-N4 - N, N4 80-200					180	250	170	194										93	80,5
B-N, B-N4 - N, N4 80-250					200	280	191	210										110	95
B-N4 - N4 80-315					250	315	220	232										154	134
B-N4 - N4 80-400 ¹⁾	125	80	125	530	280	355	268	268	160	120	435	355	80	18	42	370	140	220	192
B-N, B-N4 - N, N4 100-200	125	100	140	470	200	280	180	212	160	120	360	280	80	18	32	340	140	103	89
B-N, B-N4 - N, N4 100-250					225	315	205	233										123	104
B-N4 - N4 100-315					250	315	230	250										158	138
B-N4 - N4 100-400					530	280	355	268										280	200
B-N4 - N4 125-250	150	125	140	470	280	250	235	268	200	150	400	315	80	18	32	340	140	150	129
B-N4 - N4 125-315					280	355	247	278										217	189
B-N4 - N4 125-400					315	400	280	305										255	222
B-N4 - N4 150-315					280	400	260	298										231	201
B-N4 - N4 150-400	200	150	160	530	315	450	295	328	200	150	550	450	100	22	42	370	140	284	247

1) Дополнительный размер

Размеры и вес

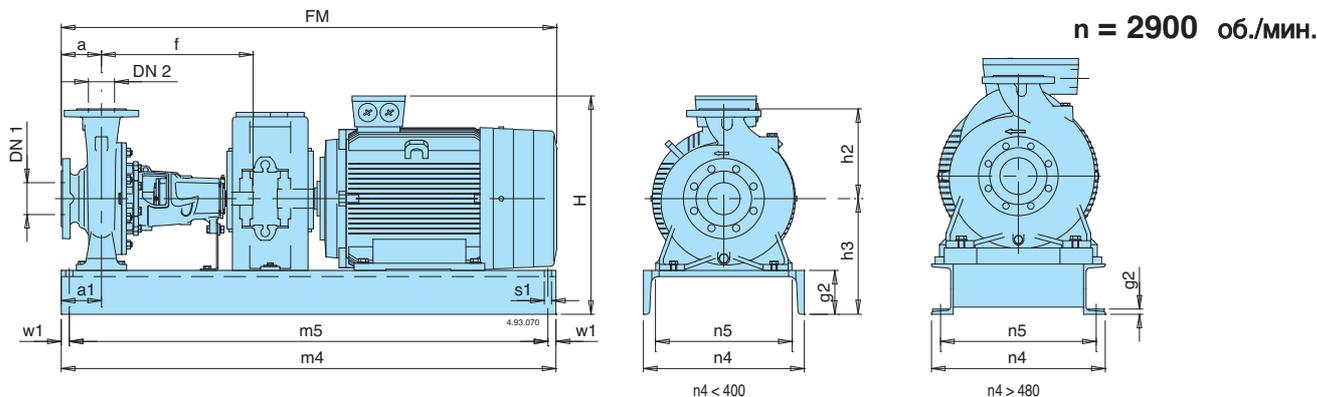

Насос	Двигатель	kW	MM															
			DN ₁	DN ₂	a	f	h ₃	h ₂	m ₄	m ₅	w ₁	n ₄	n ₅	a ₁	g ₂	s ₁	FM≈	H≈
B-N, N 32-125	71 M2	0,55	50	32	80	360	197	140	780	750	15	240	180	90	85	14	718	308
	80 M2	0,75	50	32	80	360	197	140	780	750	15	240	180	90	85	14	770	319
	80 M2	1,1	50	32	80	360	197	140	780	750	15	240	180	90	85	14	770	319
B-N, N 32-160	90 S2	1,5	50	32	80	360	197	140	780	750	15	240	180	90	85	14	825	323
	90 S2	1,5	50	32	80	360	217	160	780	750	15	240	180	90	85	14	825	343
	90 L2	2,2	50	32	80	360	217	160	780	750	15	240	180	90	85	14	865	343
B-N, N 32-200	100 L2	3	50	32	80	360	232	160	880	850	15	300	240	90	100	14	920	398
	90 L2	2,2	50	32	80	360	245	180	780	750	15	240	180	90	85	14	865	371
	100 L2	3	50	32	80	360	260	180	880	850	15	300	240	90	100	14	920	426
B-N, N 32L-160	112 M2	4	50	32	80	360	260	180	880	850	15	300	240	90	100	14	903	437
	132 S2	5,5	50	32	80	360	260	180	1020	990	15	350	290	100	100	14	954	462
	90 L2	2,2	50	32	80	360	217	160	780	750	15	240	180	90	85	14	865	343
B-N, N 32L-200	100 L2	3	50	32	80	360	232	160	880	850	15	300	240	90	100	14	920	398
	112 M2	4	50	32	80	360	232	160	880	850	15	300	240	90	100	14	903	409
	132 S2	5,5	50	32	80	360	260	180	1020	990	15	350	290	100	100	14	953	462
B-N, N 40-125	80 M2	1,1	65	40	80	360	197	140	780	750	15	240	180	90	85	14	770	319
	90 S2	1,5	65	40	80	360	197	140	780	750	15	240	180	90	85	14	825	323
	90 L2	2,2	65	40	80	360	197	140	780	750	15	240	180	90	85	14	865	323
B-N, N 40-160	90 L2	2,2	65	40	80	360	217	160	780	750	15	240	180	90	85	14	865	343
	100 L2	3	65	40	80	360	232	160	880	850	15	300	240	90	100	14	920	398
	112 M2	4	65	40	80	360	232	160	880	850	15	300	240	90	100	14	903	409
B-N, N 40-200	132 S2	5,5	65	40	80	360	232	160	1020	990	15	350	290	90	100	14	953	434
	112 M2	4	65	40	100	360	260	180	880	850	15	300	240	100	100	14	923	437
	132 S2	5,5	65	40	100	360	260	180	1020	990	15	350	290	100	100	14	973	462
B-N, N 40-250	160 M2	11	65	40	100	360	280	225	1020	990	15	350	290	100	100	14	1082	517
	160 M2	15	65	40	100	360	280	225	1020	990	15	350	290	100	100	14	1082	517
	90 L2	2,2	65	50	100	360	217	160	780	750	15	240	180	90	85	14	885	343
B-N, N 50-125	100 L2	3	65	50	100	360	232	160	880	850	15	300	240	90	100	14	940	398
	112 M2	4	65	50	100	360	232	160	880	850	15	300	240	90	100	14	923	409
	132 S2	5,5	65	50	100	360	232	160	1020	990	15	350	290	90	100	14	973	434
B-N, N 50-160	132 S2	5,5	65	50	100	360	260	180	1020	990	15	350	290	100	100	14	973	462
	132 S2	7,5	65	50	100	360	260	180	1020	990	15	350	290	100	100	14	973	462
	160 M2	11	65	50	100	360	280	200	1020	990	15	350	290	100	100	14	1082	497
B-N, N 50-200	160 M2	15	65	50	100	360	280	200	1020	990	15	350	290	100	100	14	1082	497
	160 M2	11	65	50	100	360	280	225	1020	990	15	350	290	100	100	14	1082	517
	160 M2	15	65	50	100	360	280	225	1020	990	15	350	290	100	100	14	1082	517
B-N, N 50-250	160 L2	18,5	65	50	100	360	280	225	1020	990	15	350	290	100	100	14	1142	517
	180 M2	22	65	50	100	360	280	225	1140	1110	15	350	290	100	100	14	1218	566
	112 M2	4	80	65	100	360	260	180	880	850	15	300	240	100	100	14	923	437
B-N, N 65-125	132 S2	5,5	80	65	100	360	260	180	1020	990	15	350	290	100	100	14	973	462
	132 S2	7,5	80	65	100	360	260	180	1020	990	15	350	290	100	100	14	973	462
	132 S2	5,5	80	65	100	360	260	200	1020	990	15	350	290	100	100	14	973	462
B-N, N 65-160	132 S2	7,5	80	65	100	360	260	200	1020	990	15	350	290	100	100	14	973	462
	160 M2	11	80	65	100	360	260	200	1020	990	15	350	290	100	100	14	1112	497
	160 M2	15	80	65	100	360	260	200	1020	990	15	350	290	100	100	14	1082	497
B-N, N 65-200	160 M2	15	80	65	100	360	280	225	1020	990	15	350	290	100	100	14	1082	517
	160 L2	18,5	80	65	100	360	280	225	1020	990	15	350	290	100	100	14	1142	517
	180 M2	22	80	65	100	360	280	225	1140	1110	15	350	290	100	100	14	1218	566
B-N, N 65-250	180 M2	22	80	65	100	470	310	250	1360	1320	20	400	340	130	110	18	1328	596
	200 L2	30	80	65	100	470	310	250	1360	1320	20	400	340	130	110	18	1348	625
	200 L2	37	80	65	100	470	310	250	1360	1320	20	400	340	130	110	18	1348	625
B-N, N 80-160	132 S2	7,5	100	80	125	360	280	225	1020	990	15	350	290	100	100	14	998	482
	160 M2	11	100	80	125	360	280	225	1020	990	15	350	290	100	100	14	1107	517
	160 M2	15	100	80	125	360	280	225	1020	990	15	350	290	100	100	14	1107	517
B-N, N 80-200	160 L2	18,5	100	80	125	360	280	225	1020	990	15	350	290	100	100	14	1167	517
	180 M2	22	100	80	125	470	290	250	1230	1190	20	400	340	100	110	18	1353	576
	200 L2	30	100	80	125	470	310	250	1360	1320	20	400	340	130	110	18	1373	625
B-N, N 80-250	180 M2	22	100	80	125	470	310	280	1360	1320	20	400	340	130	110	18	1353	596
	200 L2	30	100	80	125	470	310	280	1360	1320	20	400	340	130	110	18	1373	625
	200 L2	37	100	80	125	470	310	280	1360	1320	20	400	340	130	110	18	1373	625
B-N, N 100-200	225 M2	45	100	80	125	470	385	280	1250	840	205	480	430	95	16	24	1470	723
	250 M2	55	100	80	125	470	415	280	1250	840	205	480	430	95	16	24	1509	825
	160 L2	18,5	125	100	125	470	310	280	1230	1190	20	400	340	130	110	18	1263	547
B-N, N 100-250	180 M2	22	125	100	125	470	310	280	1360	1320	20	400	340	130	110	18	1353	596
	200 L2	30	125	100	125	470	310	280	1360	1320	20	400	340	130	110	18	1373	625
	200 L2	37	125	100	125	470	310	280	1360	1320	20	400	340	130	110	18	1373	625
B-N, N 100-200	225 M2	45	125	100	125	470	385	280	1250	840	205	480	430	95	16	24	1470	723
B-N, N 100-250	250 M2	55	125	100	140	470	415	280	1400	940	230	480	430	95	17,5	24	1597	938

Размеры и вес

n = 1450 об./мин.

Насос	Двигатель	kW	мм															
			DN ₁	DN ₂	a	f	h ₃	h ₂	m ₄	m ₅	w ₁	n ₄	n ₅	a ₁	g ₂	s ₁	fM≈	H≈
B-N4, N4 32-125	71 M4	0,25	50	32	80	360	197	140	780	750	15	240	180	90	85	14	718	308
B-N4, N4 32-160	71 M4	0,37	50	32	80	360	217	160	780	750	15	240	180	90	85	14	718	328
B-N4, N4 32-200	80 M4	0,55	50	32	80	360	245	180	780	750	15	240	180	90	85	14	770	367
	80 M4	0,75	50	32	80	360	245	180	780	750	15	240	180	90	85	14	770	367
B-N4, N4 40-125	71 M4	0,25	65	40	80	360	197	140	780	750	15	240	180	90	85	14	718	308
	71 M4	0,37	65	40	80	360	197	140	780	750	15	240	180	90	85	14	718	308
B-N4, N4 40-160	71 M4	0,37	65	40	80	360	217	160	780	750	15	240	180	90	85	14	718	328
	80 M4	0,55	65	40	80	360	217	160	780	750	15	240	180	90	85	14	770	339
	80 M4	0,75	65	40	80	360	217	160	780	750	15	240	180	90	85	14	770	339
B-N4, N4 40-200	90 S4	1,1	65	40	100	360	260	180	880	850	15	300	240	100	100	14	845	386
B-N4, N4 40-250	90 L4	1,5	65	40	100	360	280	225	880	850	15	350	290	100	100	14	885	406
	100 L4	2,2	65	40	100	360	280	225	880	850	15	350	290	100	100	14	929	446
	100 L4	3	65	40	100	360	280	225	880	850	15	350	290	100	100	14	929	446
B-N4, N4 50-125	71 M4	0,37	65	50	100	360	217	160	780	750	15	240	180	90	85	14	738	328
	80 M4	0,55	65	50	100	360	217	160	780	750	15	240	180	90	85	14	790	339
	80 M4	0,75	65	50	100	360	217	160	780	750	15	240	180	90	85	14	790	339
B-N4, N4 50-160	90 S4	1,1	65	50	100	360	260	180	880	850	15	300	240	100	100	14	845	386
B-N4, N4 50-200	90 S4	1,1	65	50	100	360	260	200	880	850	15	300	240	100	100	14	845	386
	90 L4	1,5	65	50	100	360	260	200	880	850	15	300	240	100	100	14	885	386
	100 L4	2,2	65	50	100	360	260	200	880	850	15	300	240	100	100	14	929	426
B-N4, N4 50-250	100 L4	2,2	65	50	100	360	280	225	880	850	15	350	290	100	100	14	929	446
	100 L4	3	65	50	100	360	280	225	880	850	15	350	290	100	100	14	929	446
	112 M4	4	65	50	100	360	280	225	880	850	15	350	290	100	100	14	912	457
B-N4, N4 65-125	80 M4	0,75	80	65	100	360	260	180	880	850	15	300	240	100	100	14	790	382
	90 S4	1,1	80	65	100	360	260	180	880	850	15	300	240	100	100	14	845	386
B-N4, N4 65-160	90 S4	1,1	80	65	100	360	260	200	880	850	15	300	240	100	100	14	845	386
	90 L4	1,5	80	65	100	360	260	200	880	850	15	300	240	100	100	14	885	386
	100 L4	2,2	80	65	100	360	260	200	880	850	15	350	290	100	100	14	929	426
B-N4, N4 65-200	100 L4	2,2	80	65	100	360	280	225	880	850	15	350	290	100	100	14	929	446
	100 L4	3	80	65	100	360	280	225	880	850	15	350	290	100	100	14	929	446
B-N4, N4 65-250	112 M4	4	80	65	100	470	310	250	1030	990	20	400	340	130	110	18	1022	487
	132 S4	5,5	80	65	100	470	310	250	1030	990	20	400	340	130	110	18	1123	512
B-N4, N4 65-315	132 S4	5,5	80	65	125	470	335	280	1030	990	20	400	340	130	110	18	1148	537
	132 M4	7,5	80	65	125	470	335	280	1030	990	20	400	340	130	110	18	1148	537
	160 M4	11	80	65	125	470	335	280	1230	1190	20	400	340	130	110	18	1237	572
B-N4, N4 80-160	90 S4	1,1	100	80	125	360	280	225	880	850	15	350	290	100	100	14	870	406
	90 L4	1,5	100	80	125	360	280	225	880	850	15	350	290	100	100	14	910	406
	100 L4	2,2	100	80	125	360	280	225	880	850	15	350	290	100	100	14	954	446
B-N4, N4 80-200	100 L4	2,2	100	80	125	470	280	250	1020	990	15	350	290	100	100	14	1064	446
	100 L4	3	100	80	125	470	280	250	1020	990	15	350	290	100	100	14	1064	446
	112 M4	4	100	80	125	470	280	250	1020	990	15	350	290	100	100	14	1047	457
B-N4, N4 80-250	112 M4	4	100	80	125	470	310	280	1030	990	20	400	340	130	110	18	1047	487
	132 S4	5,5	100	80	125	470	310	280	1030	990	20	400	340	130	110	18	1148	512
	132 M4	7,5	100	80	125	470	310	280	1030	990	20	400	340	130	110	18	1148	512
B-N4, N4 80-315	160 M4	11	100	80	125	470	360	315	1230	1190	20	400	340	130	110	18	1237	597
	160 L4	15	100	80	125	470	360	315	1230	1190	20	400	340	130	110	18	1297	597
	180 M4	18,5	100	80	125	470	360	315	1360	1320	20	400	340	130	110	18	1301	646
B-N4, N4 80-400	180 M4	18,5	125	80	125	530	445	355	1250	840	205	480	430	115	16	24	1361	731
	180 L4	22	125	80	125	530	445	355	1250	840	205	480	430	115	16	24	1391	760
	200 L4	30	125	80	125	530	445	355	1250	840	205	480	430	115	16	24	1439	760
	225 S4	37	125	80	125	530	445	355	1250	840	205	480	430	115	16	24	1481	783
B-N4, N4 100-200	100 L4	3	125	100	125	470	310	280	1030	990	20	400	340	130	110	18	1064	476
	112 M4	4	125	100	125	470	310	280	1030	990	20	400	340	130	110	18	1047	487
	132 S4	5,5	125	100	125	470	310	280	1030	990	20	400	340	130	110	18	1148	512
B-N4, N4 100-250	132 M4	7,5	125	100	140	470	335	280	1030	990	20	400	340	130	110	18	1163	537
	160 M4	11	125	100	140	470	335	280	1230	1190	20	400	340	130	110	18	1252	572
B-N4, N4 100-315	160 M4	11	125	100	140	470	360	315	1230	1190	20	400	340	130	110	18	1252	597
	160 L4	15	125	100	140	470	360	315	1230	1190	20	400	340	130	110	18	1312	597
	180 M4	18,5	125	100	140	470	360	315	1360	1320	20	400	340	130	110	18	1316	646
B-N4, N4 100-400	180 L4	22	125	100	140	530	445	355	1250	840	205	480	430	115	16	24	1406	760
	200 L4	30	125	100	140	530	445	355	1250	840	205	480	430	115	16	24	1454	760
	225 S4	37	125	100	140	530	445	355	1250	840	205	480	430	115	16	24	1496	783
B-N4, N4 125-250	132 S4	5,5	150	125	140	470	360	355	1030	990	20	400	340	130	110	18	1163	562
	132 M4	7,5	150	125	140	470	360	355	1030	990	20	400	340	130	110	18	1163	562
	160 M4	11	150	125	140	470	360	355	1230	1190	20	400	340	130	110	18	1252	597
	160 L4	15	150	125	140	470	360	355	1230	1190	20	400	340	130	110	18	1312	597
B-N4, N4 125-315	180 M4	18,5	150	125	140	530	445	355	1250	840	205	480	430	115	16	24	1376	731
	180 L4	22	150	125	140	530	445	355	1250	840	205	480	430	115	16	24	1406	760
	200 L4	30	150	125	140	530	445	355	1250	840	205	480	430	115	16	24	1454	760
B-N4, N4 125-400	225 S4	37	150	125	140	530	480	400	1250	840	205	480	430	115	16	24	1496	818
	225 M4	45	150	125	140	530	480	400	1250	840	205	480	430	115	16	24	1556	818
	250 M4	55	150	125	140	530	540	400	1400	940	230	510	450	115	17,5	24	1595	950
B-N4, N4 150-315	180 M4	18,5	200	150	160	530	445	400	1250	840	205	480	430	115	16	24	1396	731
	180 L4	22	200	150	160	530	445	400	1250	840	205	480	430	115	16	24	1426	760
	200 L4	30	200	150	160	530	445	400	1250	840	205	480	430	115	16	24	1474	760
	225 S4	37	200	150	160	530	445	400	1250	840	205	480	430	115	16	24	1516	783
B-N4, N4 1																		

Вид в разрезе

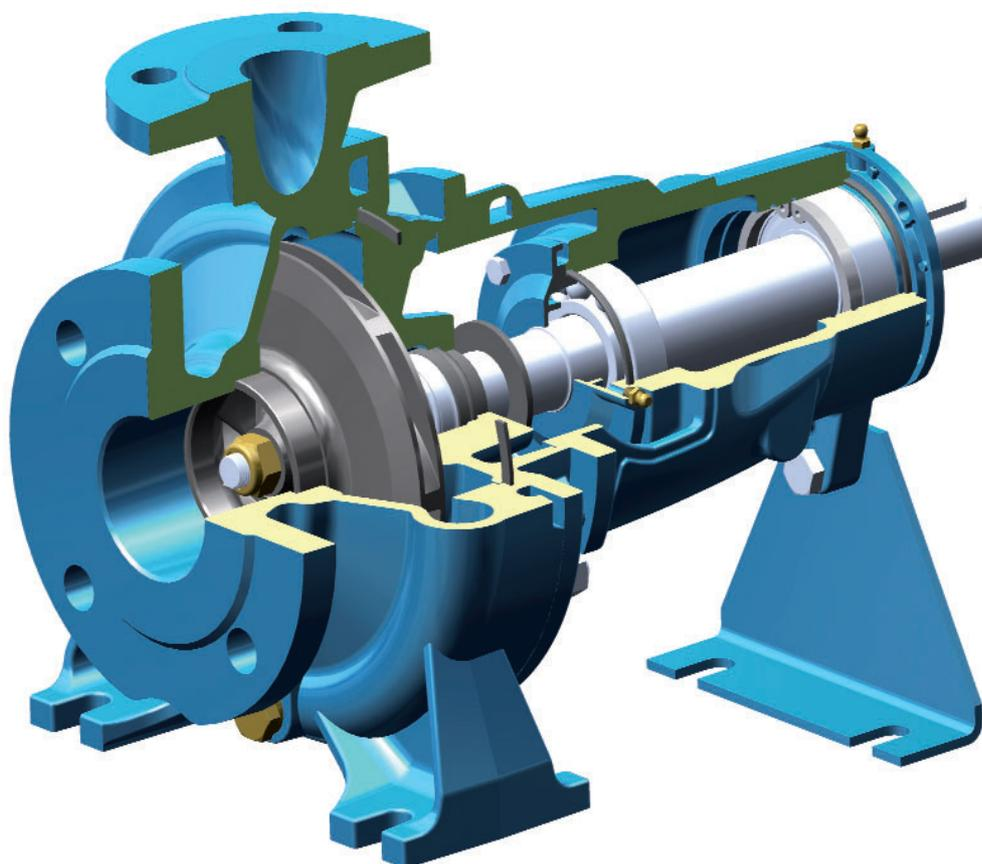
**ГИДРАВЛИКА НА ВЫСШЕМ УРОВНЕ**

Геометрия рабочего колеса и корпуса насоса оптимизированы для достижения максимальной эффективности и высокой мощности всасывания.

ГИБКОСТЬ

Возможность выбора материала (чугуна или бронзы) для части, контактирующей с жидкостью, что позволяет использовать насосы с жидкостями различной природы.

ПРОЧНАЯ КОНСТРУКЦИЯ

Механическая конструкция частей, контактирующих с жидкостью, рассчитана таким образом, чтобы гарантировать максимальную устойчивость к механическим воздействиям. Также крышка корпуса снабжена плавниками-стабилизаторами, которые предотвращают турбулентность в области механического уплотнения, что значительно увеличивает прочность насоса.

НАДЕЖНОСТЬ

Параметры подшипников и вала разработаны таким образом, чтобы обеспечивать снижение напряжения для достижения высокой надежности при любых условиях эксплуатации.